

ALKOR

ALUMINUM



YALITIMSIZ SÜRME SİSTEMLERİ

UNINSULATED SLIDING SYSTEMS











- **LIGHT SÜRME** / LIGHT SLIDING
- **SOFT SÜRME** / SOFT SLIDING
- **ALK 3800**
- **BÜYÜK TUBA**

SOFT SÜRME

SOFT SLIDING



İçindekiler / Contents

Profil Profile	Profil Kodu Profile No	Ağırlık (kg/m.) Weight (kg/m.)	X mm.	Y mm.	Jx cm ⁴	Jy cm ⁴
	2018 Kasa Profili Frame Profile	0,899	59 mm.	46,5 mm.	13,67	5,41
	2755 Pervazlı Kasa Pr. Frame Profile	1,167	67,75 mm.	47,3 mm.	15,87	7,52
	2019 Kanat Profili Sash Profile	0,872	32 mm.	65,5 mm.	11,50	5,57
	2021 Adaptör Profili Adapter Profile	0,354	36 mm.	38 mm.	---	---
	2757 Adaptör Profili Adapter Profile	0,286	29,5 mm.	28,5 mm.	---	---
	374 Adaptör Profili Adapter Profile	0,289	29,5 mm.	17,5 mm.	---	---
	995 Sineklik Çıta Pr. Glazing Bead Pr.	0,146	15 mm.	10 mm.	---	---
	996 Sineklik Kanat Pr. Sash Profile	0,669	20 mm.	57 mm.	---	---
	2756 Sineklik Ray Pr. Rail Profile	0,411	28,7 mm.	42,53 mm.	---	---
	2757A Sineklik Adaptör Pr. Adapter Profile	0,193	19 mm.	20,6 mm.	---	---

Profiller / Profiles

Kasa Profili - Frame Profile

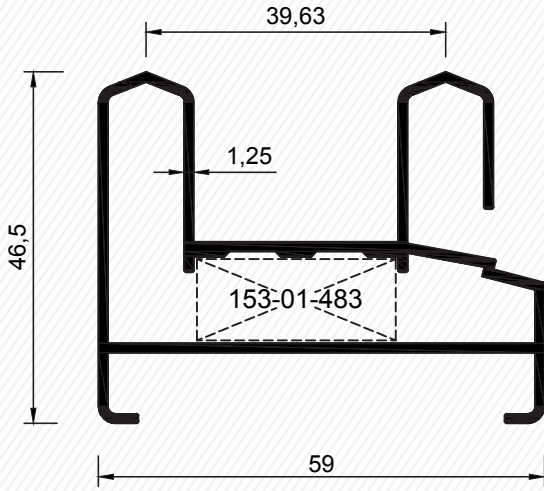
2018
0,899 kg/mt

2018

Pervazlı Kasa Profili - Frame Profile

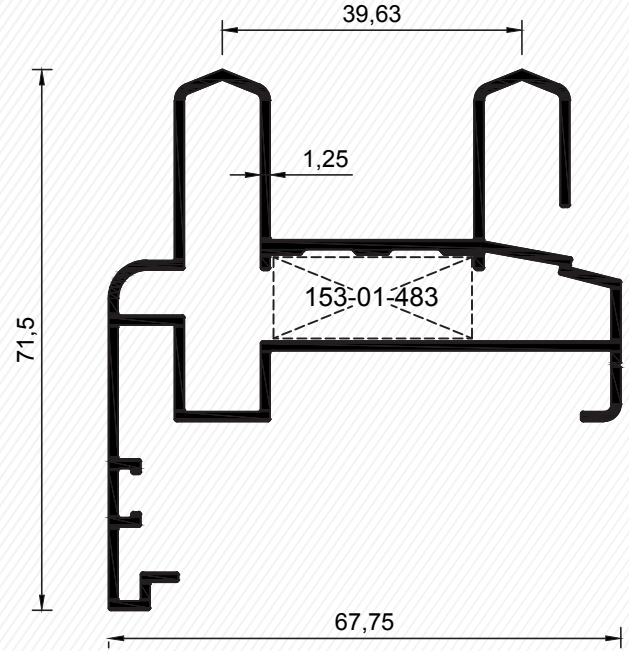
2755
1,167 kg/mt

2755

Kod	Et Kalın.	Ürün Adı	Ağırlığı
2018	1,25 mm	Kasa Profili	0,899 kg/mt
2755	1,25 mm	Pervazlı Kasa Pr.	1,167 kg/mt

Kanat Profili - Sash Profile

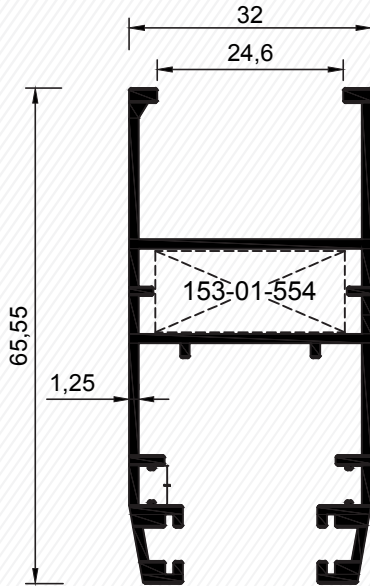
2019
0,872 kg/mt

2019

Adaptör Profili - Adapter Profile

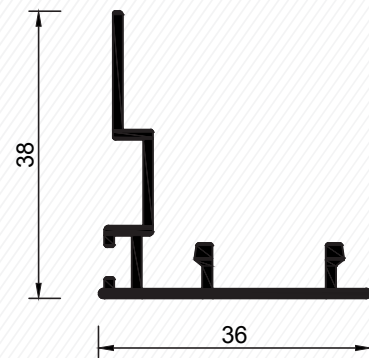
2021
0,354 kg/mt

2021

Kod	Et Kalın.	Ürün Adı	Ağırlığı
2019	1,25 mm	Kanat Profili	0,872 kg/mt
2021	1,3 mm	Adaptör Profili	0,354 kg/mt

Profiller / Profiles

Adaptör Profili - Adapter Profile

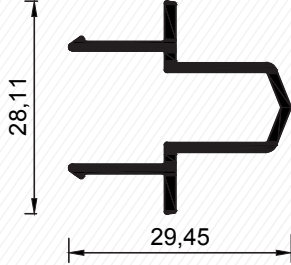
**2757**
(0,286 kg/mt)

Tek Cam Adaptör Profili - Adapter Profile

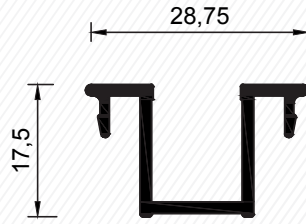
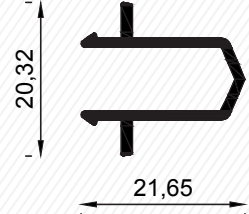
**374**
(0,289 kg/mt)Sineklik Adaptör Profili
Fly Screen Adapter Profile**2757A**
(0,203 kg/mt)

Sineklik Ray Profili - Fly Screen Rail Profile

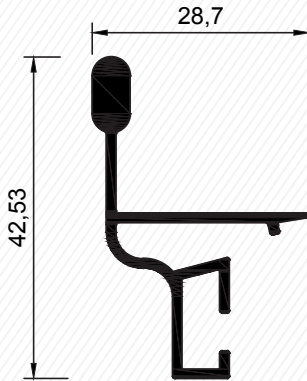
**2756**
(0,411 kg/mt)

Sineklik Çıta Profili - Fly Screen Beat Profile

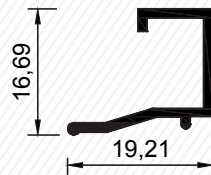
**995**
(0,146 kg/mt)

Sineklik Kanat Profili - Fly Screen Sash Profile

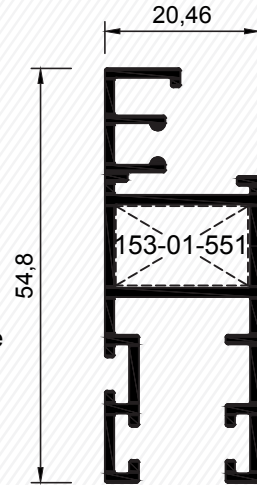
**996**
(0,669 kg/mt)

Detaylar / Details

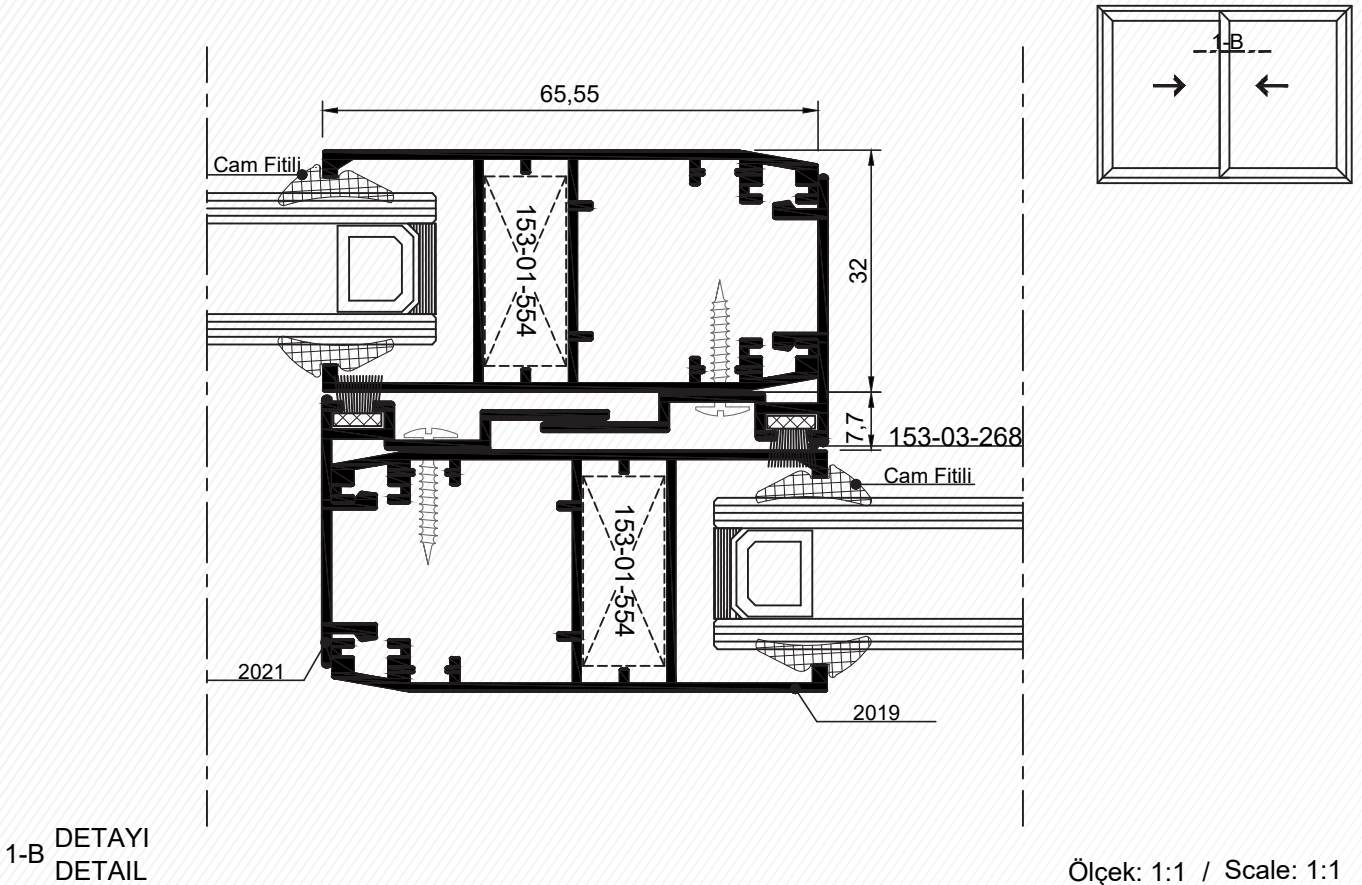
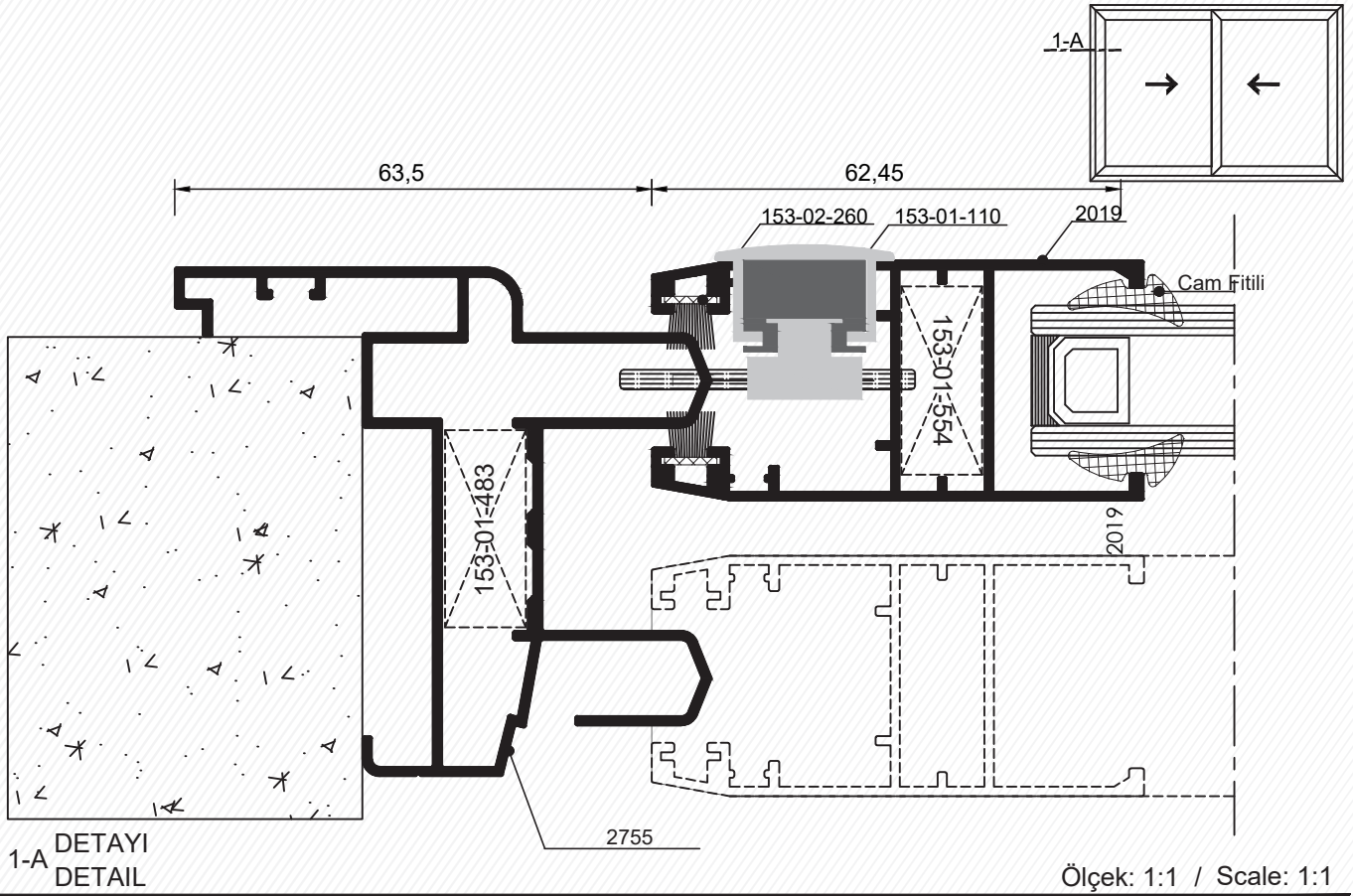

Detaylar / Details

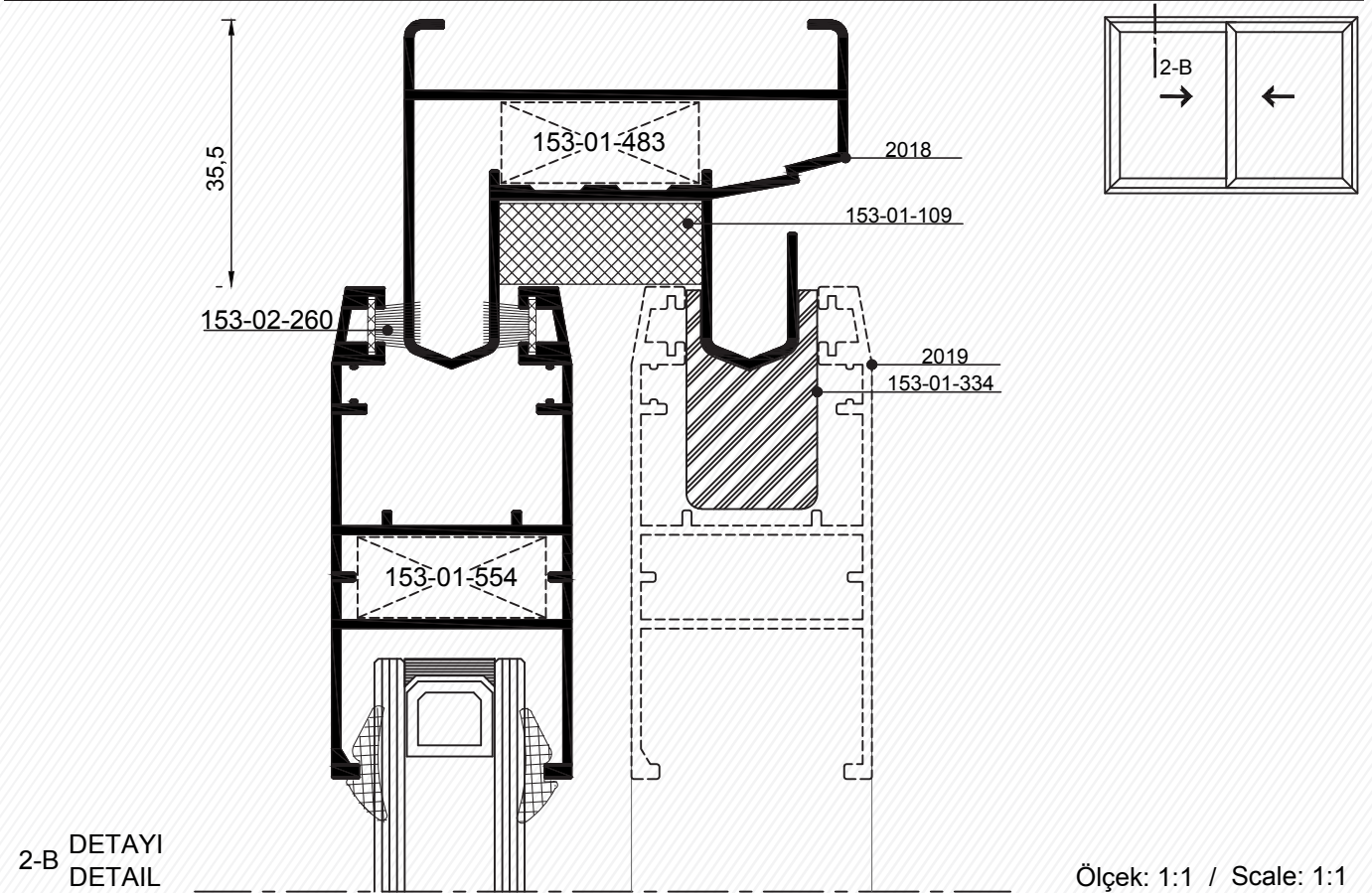
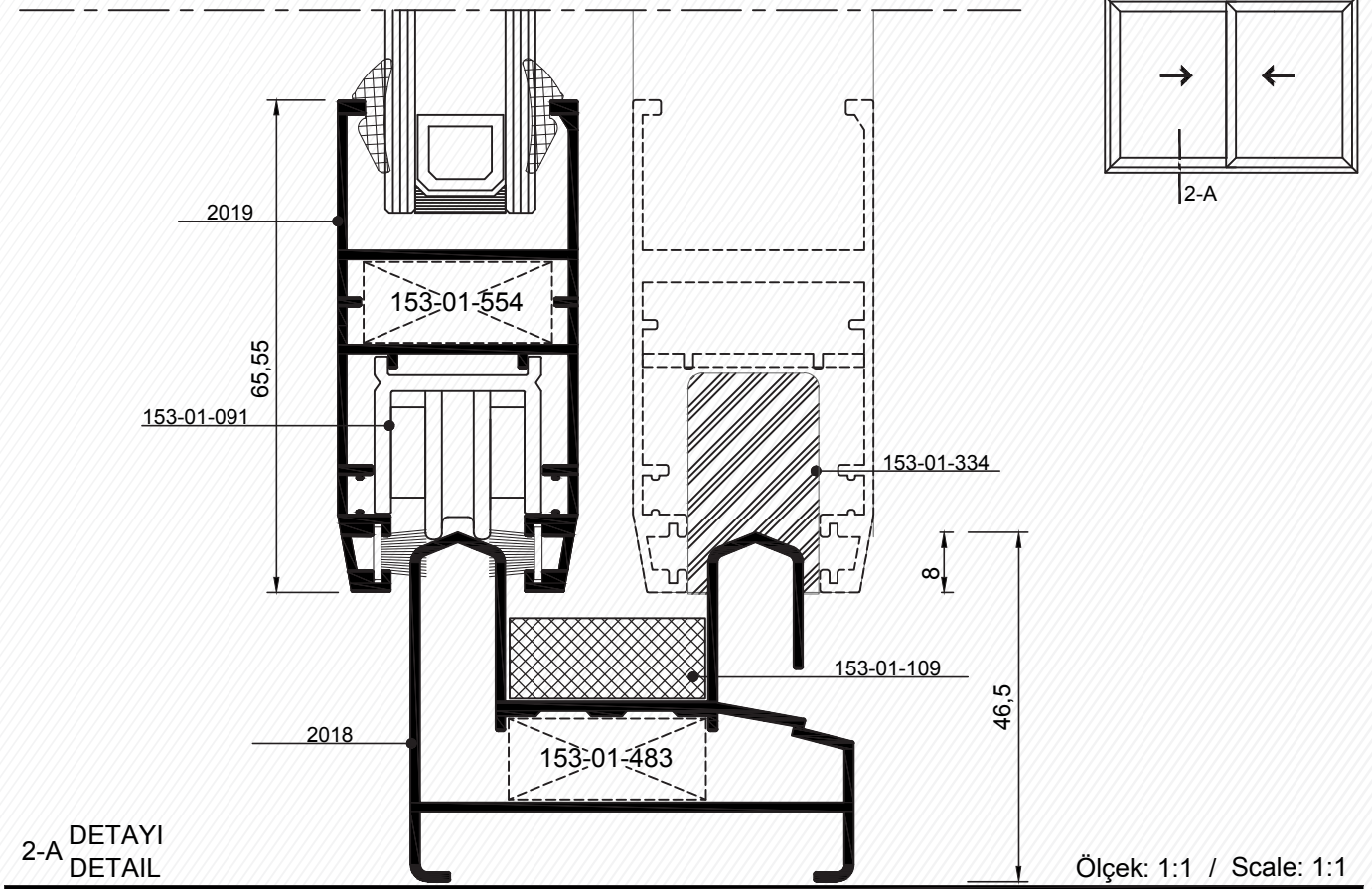

Detaylar / Details

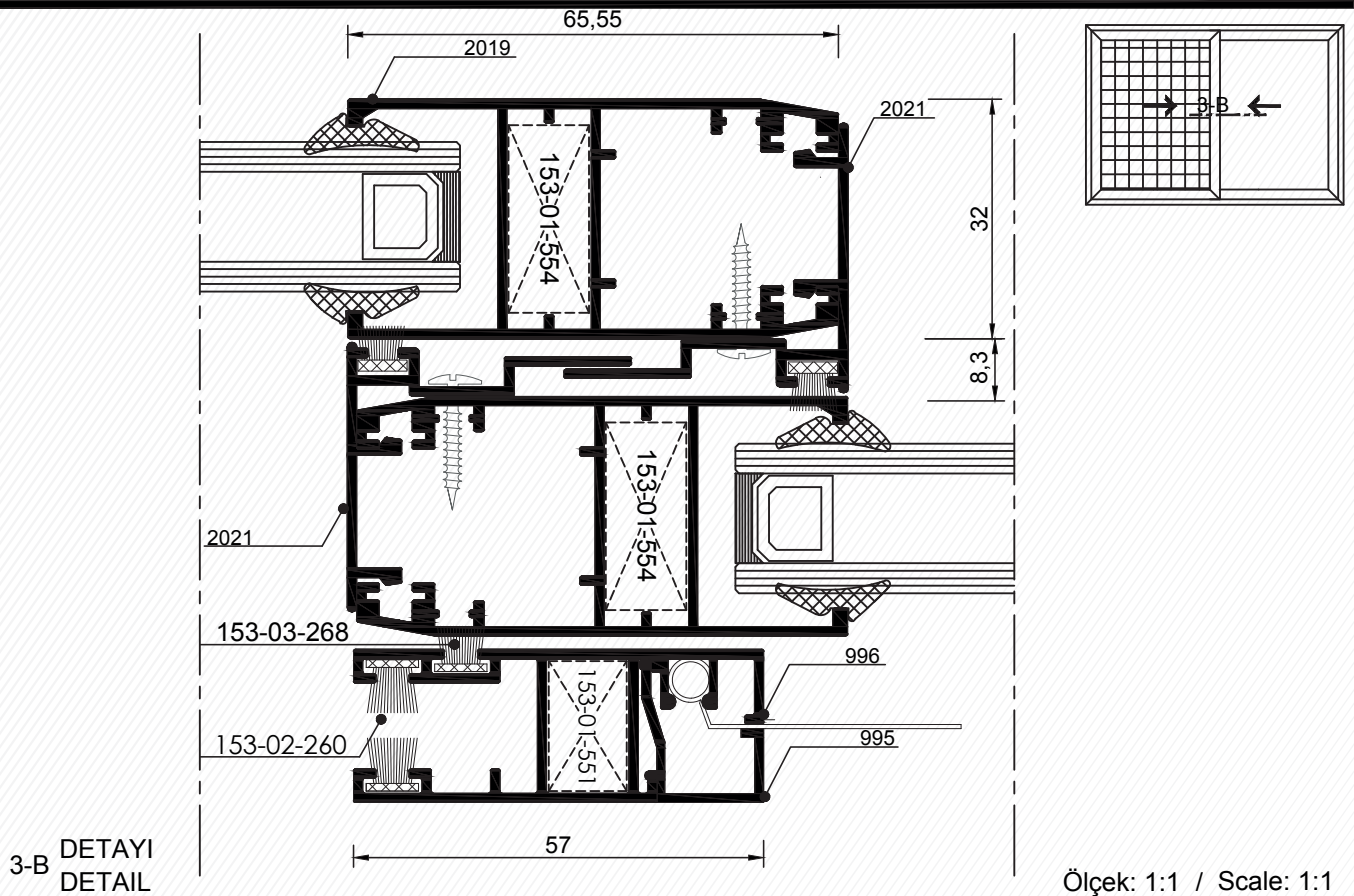
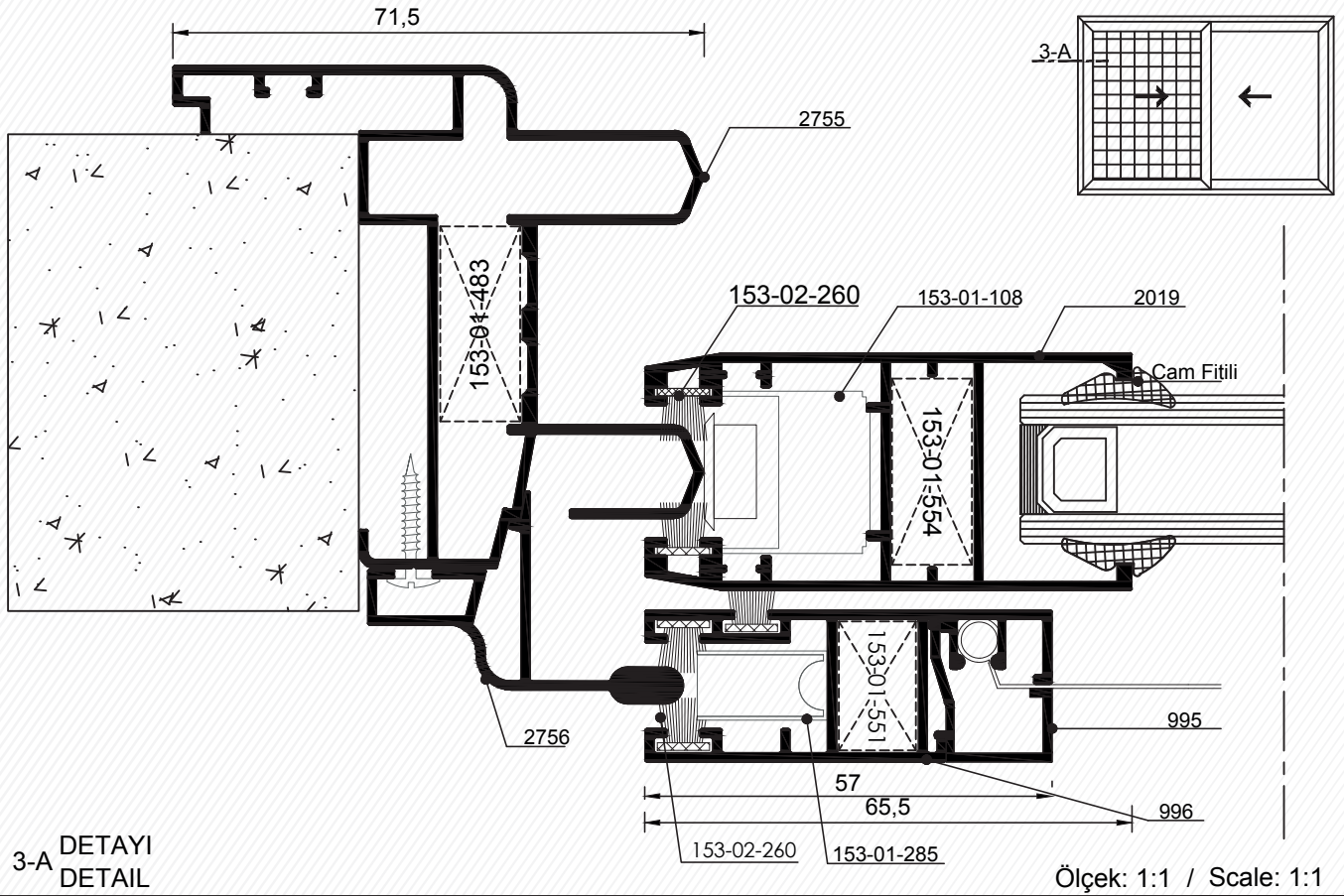

Detay / Details

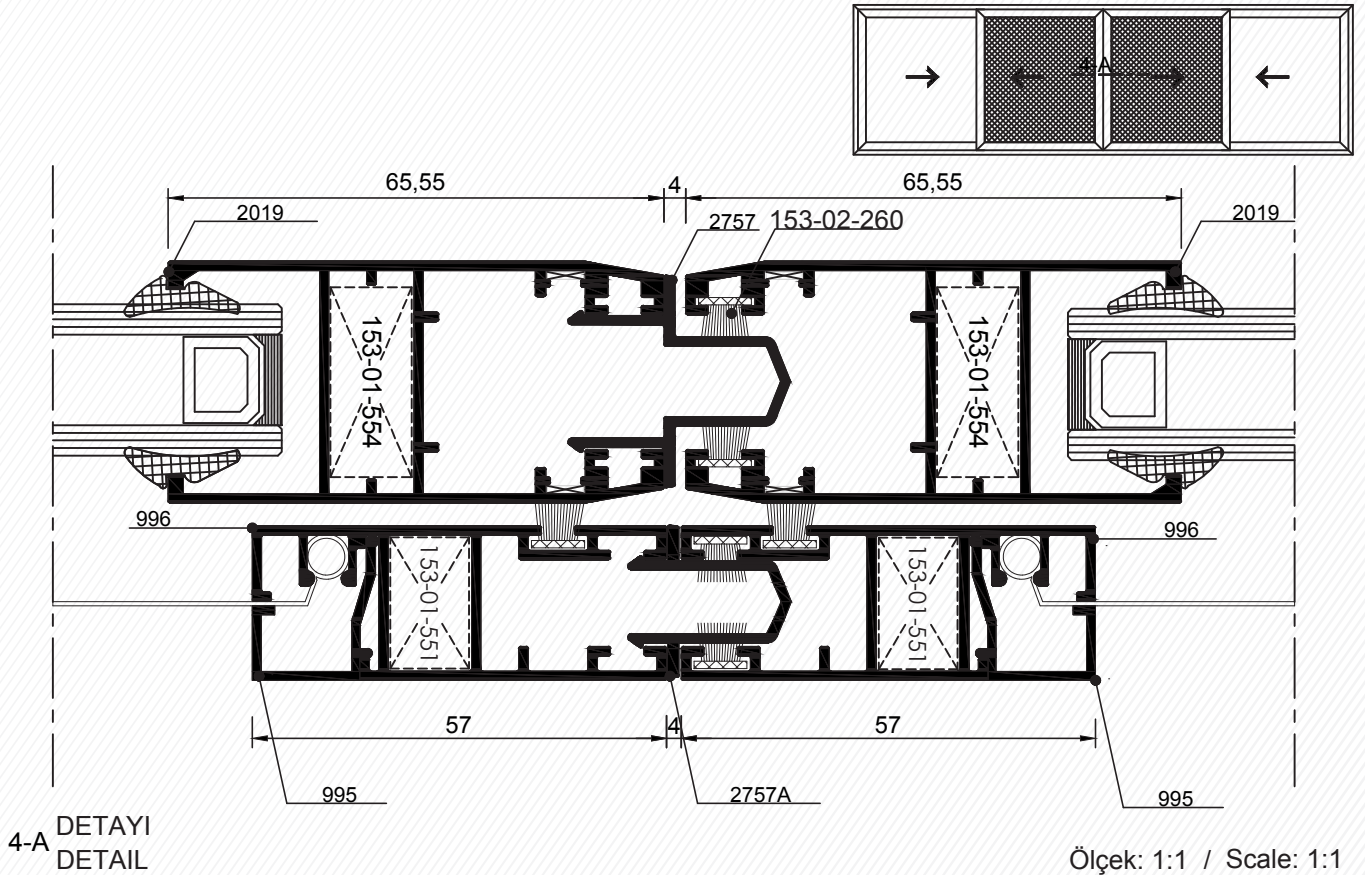

Kesim Ölçüsü / Cut Dimension

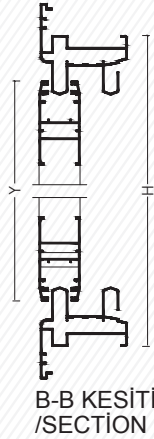
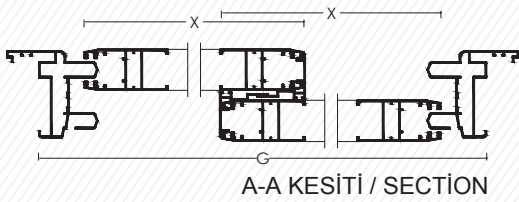
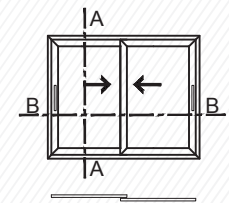

İKİ KANATLI SÜRME FORMÜLÜ
TWO SASHES SLIDING FORMULA

$X = G/2 - 6,32 \text{ mm}$	G = Kasa Genişliği / Frame Width
$Y = H - 77 \text{ mm}$	H = Kasa Yüksekliği / Frame Height
	X = Kanat Genişliği / Sash Width
	Y = Kanat Yüksekliği / Sash Height

CAM FORMÜLÜ / GLASS FORMULA



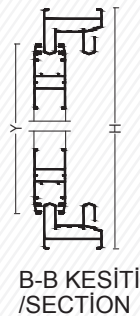
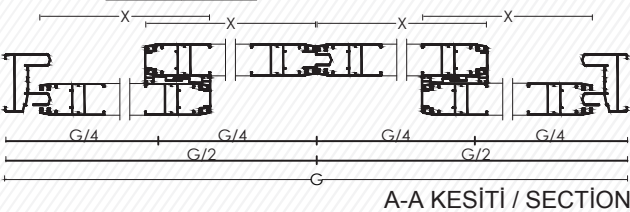
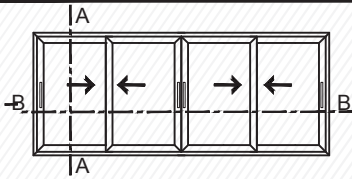

$Cx = G/2 - 107,4 \text{ mm}$	G = Kasa Genişliği / Frame Width
$Cy = H - 178,1 \text{ mm}$	H = Kasa Yüksekliği / Frame Height
	Cx = Cam Genişliği / Glass Width
	Cy = Cam Yüksekliği / Glass Height

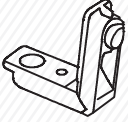
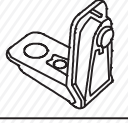
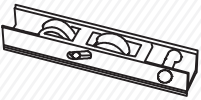
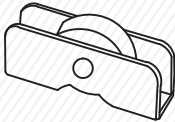

DÖRT KANATLI SÜRME FORMÜLÜ
FOUR SASHES SLIDING FORMULA

$X = G/4 + 12,20 \text{ mm}$	G = Kasa Genişliği / Frame Width
$Y = H - 77 \text{ mm}$	H = Kasa Yüksekliği / Frame Height
	X = Kanat Genişliği / Sash Width
	Y = Kanat Yüksekliği / Sash Height

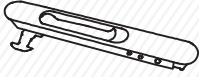
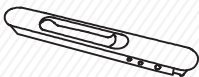
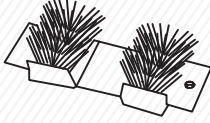
Aksesuarlar / Accessories

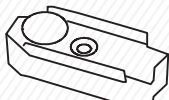
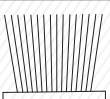
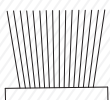
Ürün Çizimi Drawing	Ürün Kodu Product No	Ürün Adı Product Name	Kullanıldığı Profiller Profiles Used
	153-01-554	Kanat Köşe Takoza Joint Corner for Sash	2019
	153-01-483	Kasa Köşe Takoza Joint Corner for Frame	2018-2755
	153-01-091	Rulman Roller	2019
	153-01-285	Sineklik Rulman Fly Screen Roller	996
	153-01-551	Sineklik Köşe Takoza Joint Corner for Fly Screen	996
	153-01-110 153-01-111 153-01-112	Oval Sürme Kilit Locker for Sliding Doors 110-Gümüş 111-Siyah 112-Beyaz 110-Silver 111-Black 112-White	2019
	153-01-406 153-01-407 153-01-408	Oval Sürme Havuz Kol (Pencere) Locker for Sliding Windows 406-Gümüş 407-Renkli 408-Beyaz 406-Silver 407-Color 408-White	2019
	153-01-109	Tozluk Brush with Sticky Back	2018-2755
	153-01-334	Adaptör Tapası Connector Tap	2021
	153-01-108	Stoplama Stopper	2019
	153-03-268	500'lik Kıl Fitol Brush Roving	2021
	153-02-260	600'lik Kıl Fitol Brush Roving	2019

Aksonometri / Axometry

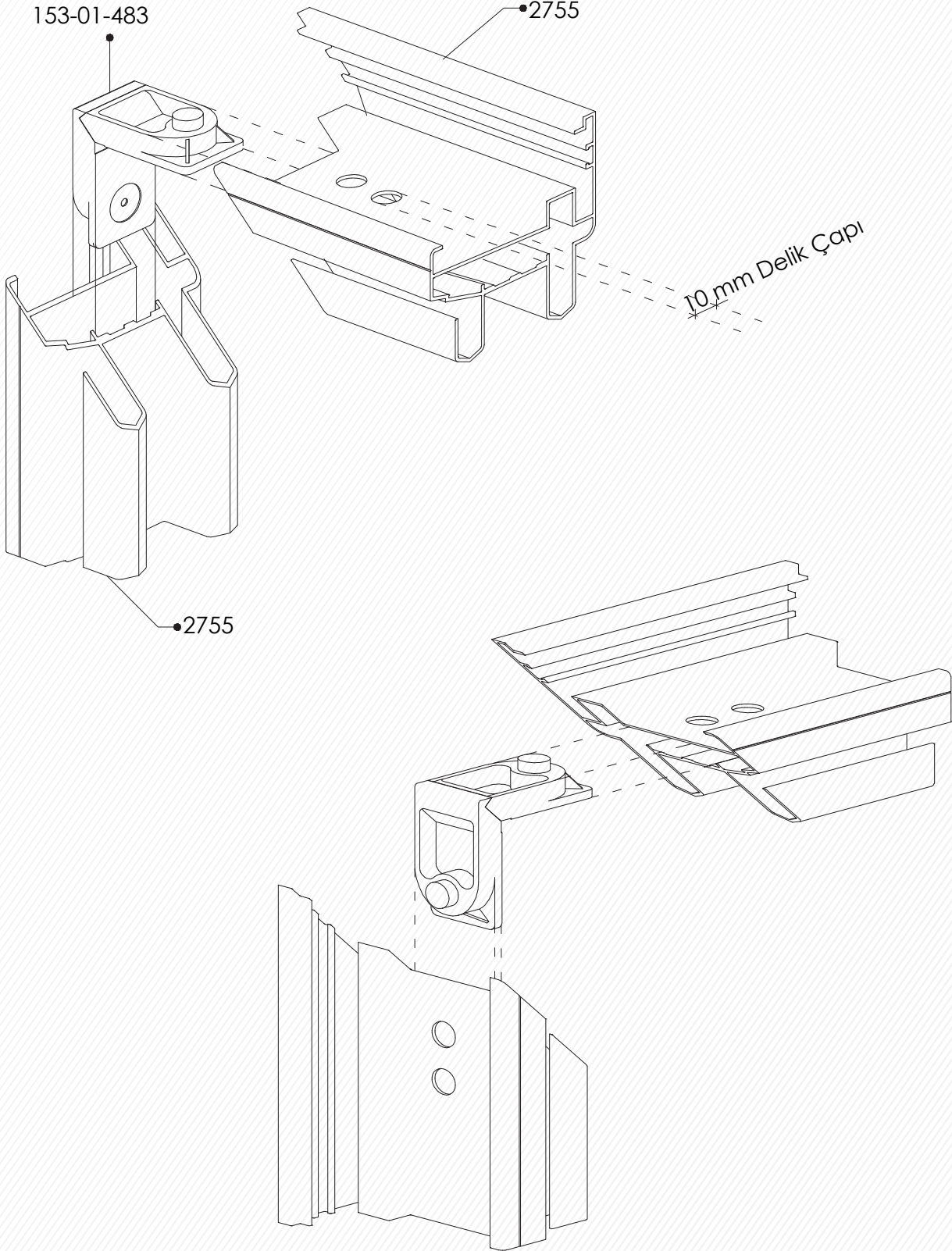

Aksonometri / Axometry

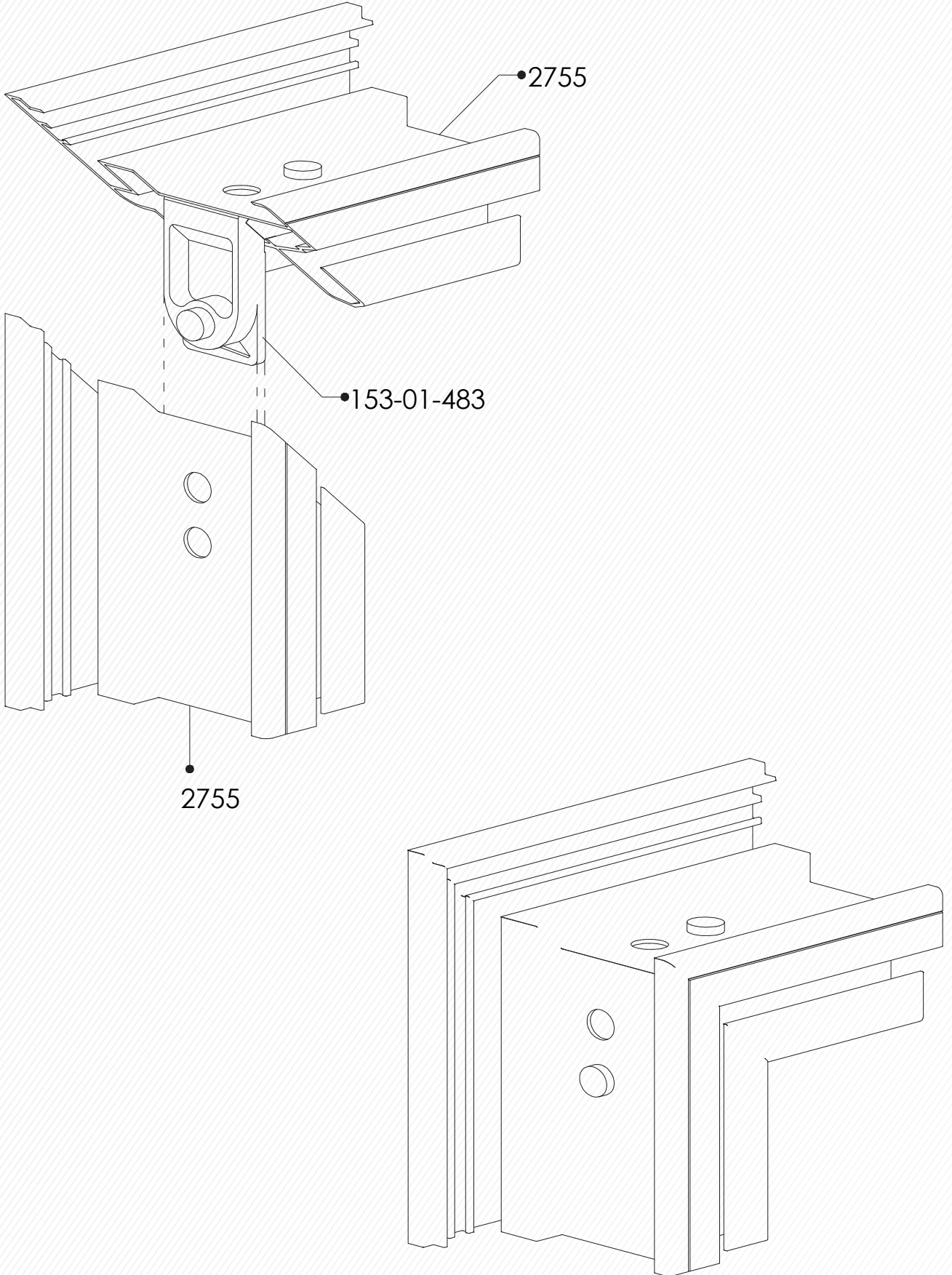

Aksonometri / Axometry

