

ALKOR

ALUMINUM



YALITIMLI KAPI & PENCERE SİSTEMLERİ



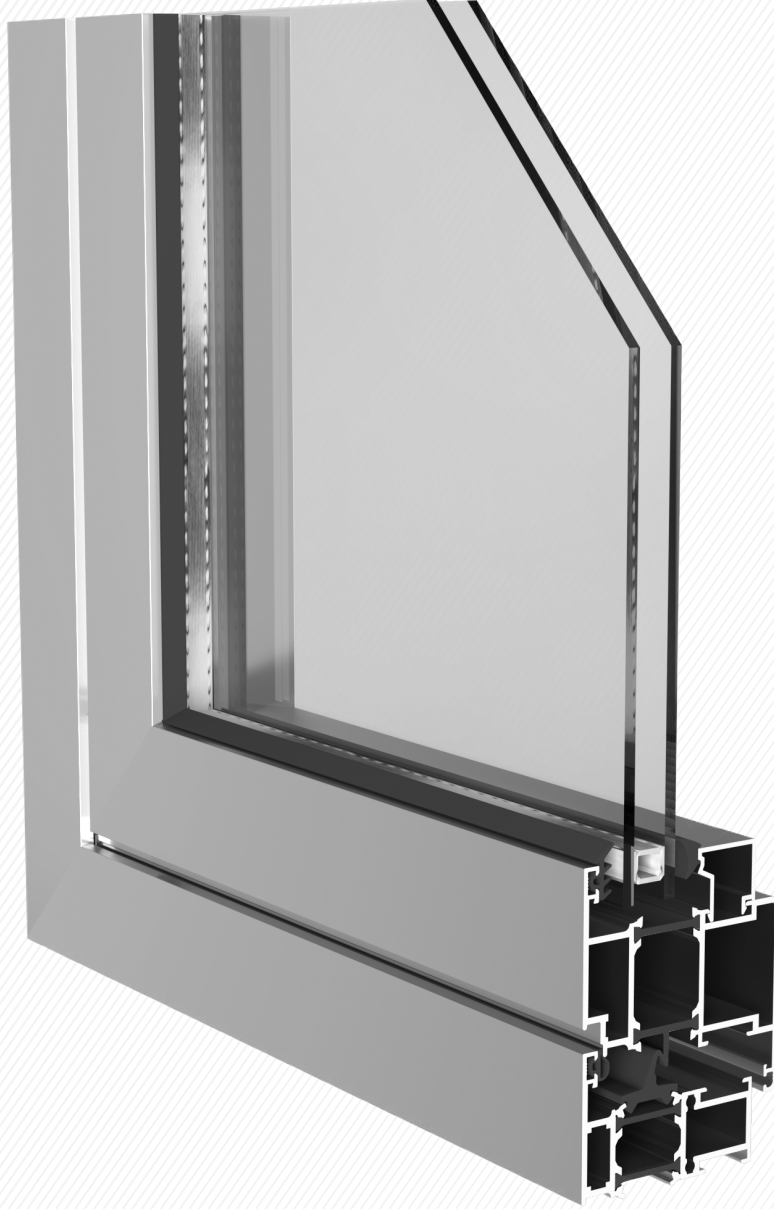

INSULATED DOOR AND WINDOW SYSTEMS

- ALK 5500 T
- ALK 6500 T
- ALK 8800



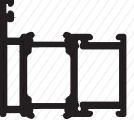
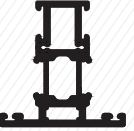

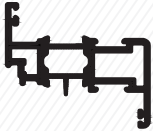
ALK 6500T

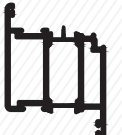
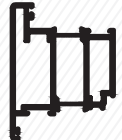
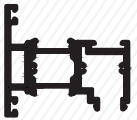
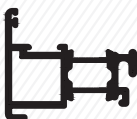

İçindekiler / Contents

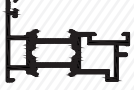
Profil Profile	Profil Kodu Profile No	Ağırlık (kg/m.) Weight (kg/m.)	X mm.	Y mm.	Jx cm ⁴	Jy cm ⁴
	3928-3930 Kasa Profili Frame Profile	1,424kg/m	65 mm	46 mm	10,5	37,01
	3870-3871 Kasa Profili Frame Profile	1,710kg/m	65 mm	61 mm	15,05	32,23
	3928-3929 Orta Kayıt Profili Mullion Profile	1,554kg/m	65 mm	65 mm	39,10	17,32
	3871-3872 Geniş Orta Kayıt Pr. Mullion Profile	1,840kg/m	65 mm	80 mm	23,40	12,10
	3864-3865 Duble Orta Kayıt Pr. Mullion Profile	2,974kg/m	65 mm	135 mm	43,66	79,06
	3931-3932 Kanat Profili Sash Profile	1,596kg/m	75 mm	46 mm	6,41	26,99
	3866-3867 Kanat Profili Sash Profile	1,907kg/m	75 mm	80 mm	15,00	33,65
	3855-3856 Kanat Profili Sash Profile	2,316kg/m	75 mm	100 mm	32,90	44,64
	3862-3863 Dışa Açılım KapıKanat Profili Door Sash Profile	2,389kg/m	75 mm	100 mm	31,00	45,01
	3874-3876 Adaptör Profili Adapter Profile	1,502kg/m	65mm	58 mm	9,28	21,62
	3935-3936 Pivot Adaptör Profili Adapter Profile	1,466kg/m	58 mm	69 mm	22,09	6,72

İçindekiler / Contents

Profil Profile	Profil Kodu Profile No	Ağırlık (kg/m.) Weight (kg/m.)	X mm.	Y mm.	Jx cm ⁴	Jy cm ⁴
	3873-3875 Adaptör Profili Adapter Profile	1,201kg/m	65 mm	45 mm	7,13	23,35
	3868 Çita Profili Bead Glazing Profile	0,348kg/m	38,2 mm	22,3 mm	----	----
	3869 Çita Profili Bead Glazing Profile	0,281kg/m	22,5 mm	22,7 mm	----	----
	5139 Çita Profili Bead Glazing Profile	0,245kg/m	15,8 mm	22,6 mm	----	----
	1325 Tij Profili Rod Profile	0,125kg/m	19,5 mm	4,3 mm	----	----

Profiller / Profiles

Kasa Profili - Frame Profile
3928-3930
1,424 kg/mt

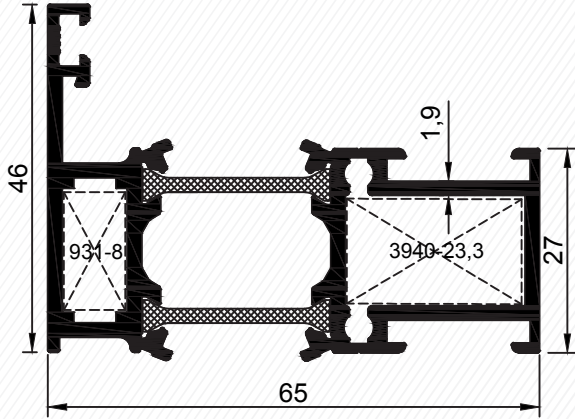

3928-3930

Geniş Kasa Profili - Frame Profile
3870-3871
1,710 kg/mt

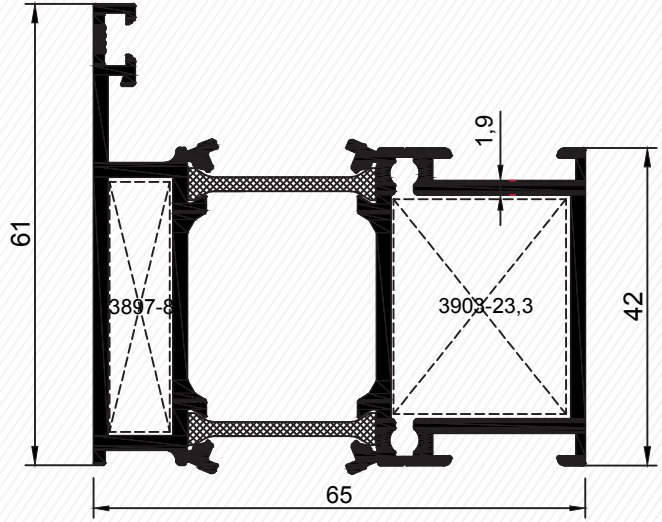

3870-3871

Kod	Et Kalın.	Ürün Adı	Ağırlığı	Köşe Takozu
3930-3928	1,9 mm	Kasa Profili	1,424 kg/mt	931-8 mm 3940-23,3 mm
3870-3871	1,9 mm	Kasa Profili	1,710 kg/mt	3897-8 mm 3903-23,3 mm

Orta Kayıt Profili - Mullion Profile
3929-3928

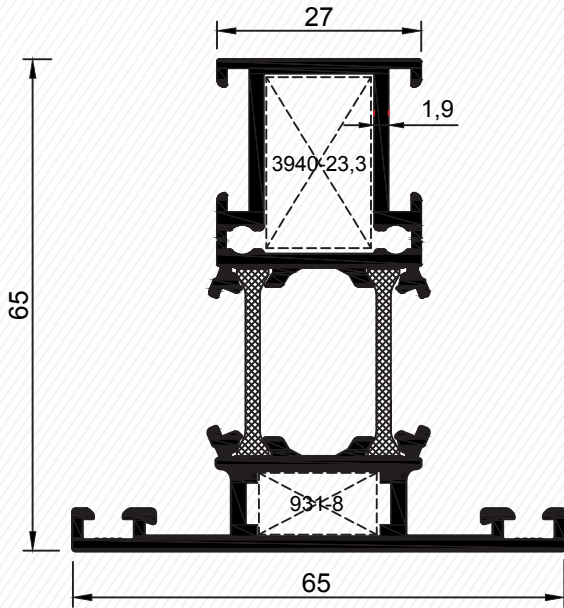

3929-3928

Geniş Orta Kayıt Profili - Mullion Profile
3872-3871
1,840 kg/mt

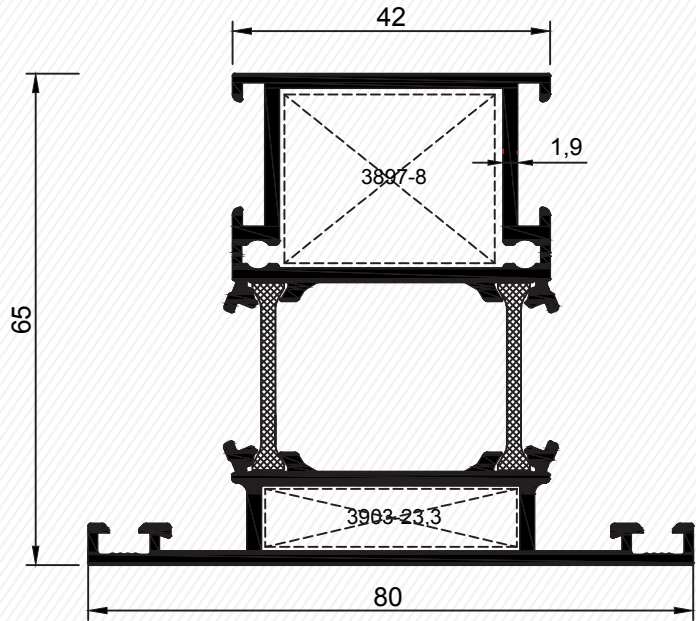

3872-3871

Kod	Et Kalın.	Ürün Adı	Ağırlığı	Köşe Takozu
3929-3928	1,9 mm	"T" Profili	1,554 kg/mt	931-8 mm 3940-23,3 mm
3872-3871	1,9 mm	"T" Profili	1,840 kg/mt	3897-8 mm 3903-23,3 mm

Profiller / Profiles

Duple Orta Kayıt Profili - Double Mullion Profile

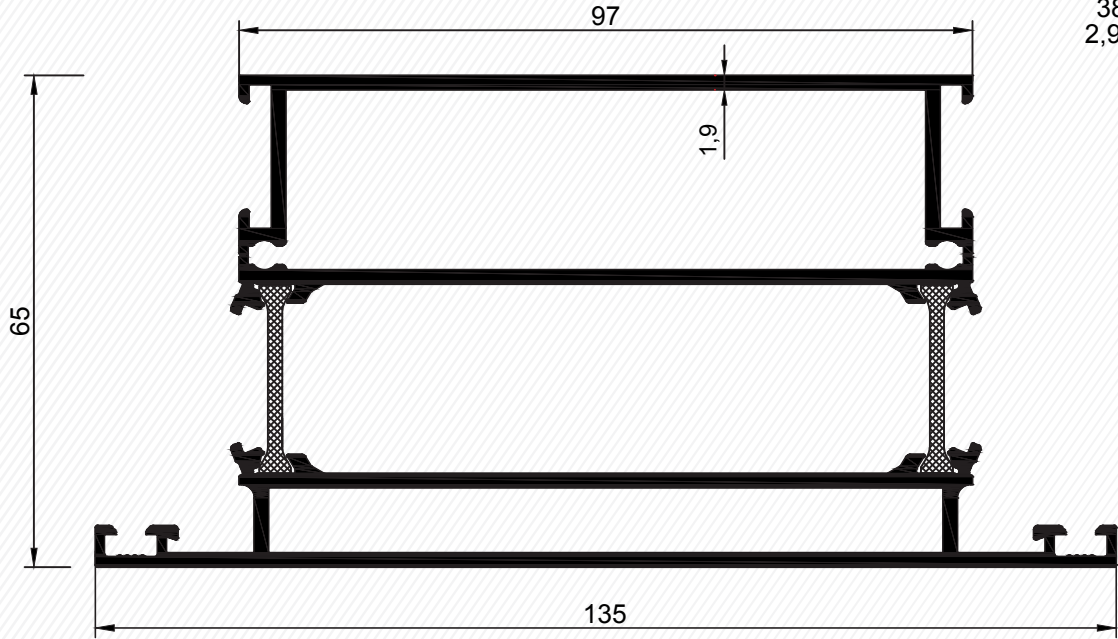
 3864-3865
 2,974 kg/mt

3864-3865

Kod	Et Kalın.	Ürün Adı	Ağırlığı	Köşe Takozu
3864-3865	1,9 mm	"T" Profili	2,974 kg/mt	

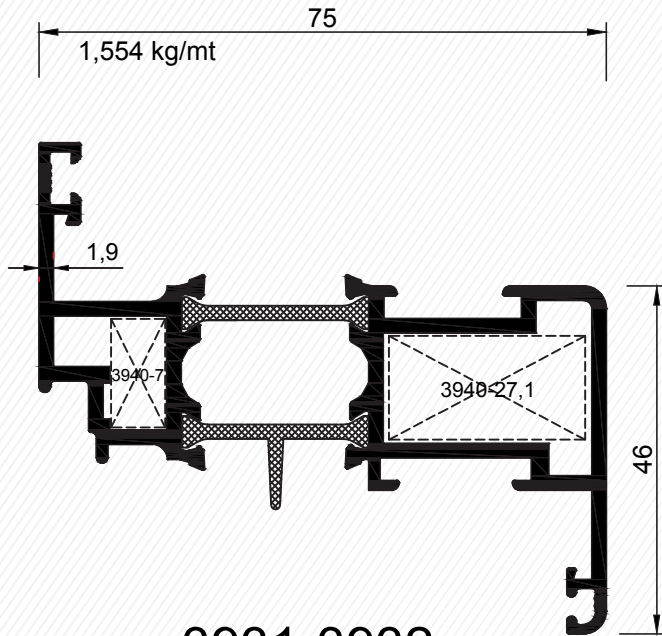
Kanat Profili - Sash Profile

 3931-3932
 1,596 kg/mt

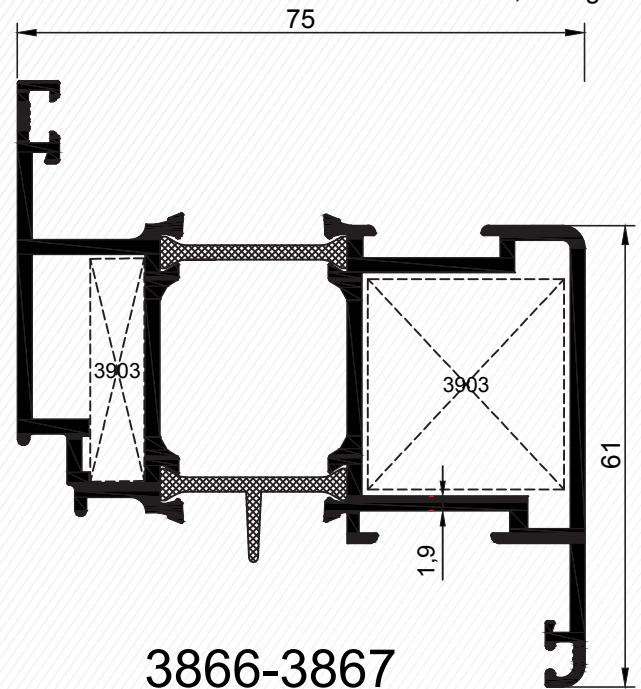
3931-3932

Geniş Kanat Profili - Large Sash Profile

 3866-3867
 1,907 kg/mt

3866-3867

Kod	Et Kalın.	Ürün Adı	Ağırlığı	Köşe Takozu
3931-3932	1,9 mm	Kanat Profili	1,596 kg/mt	3940-7 mm 3940-27,1 mm
3866-3867	1,9 mm	Kanat Profili	1,907 kg/mt	3903-7 mm 3903-27,1 mm

Profiller / Profiles

Kapı Kanat Profili - Door Sash Profile

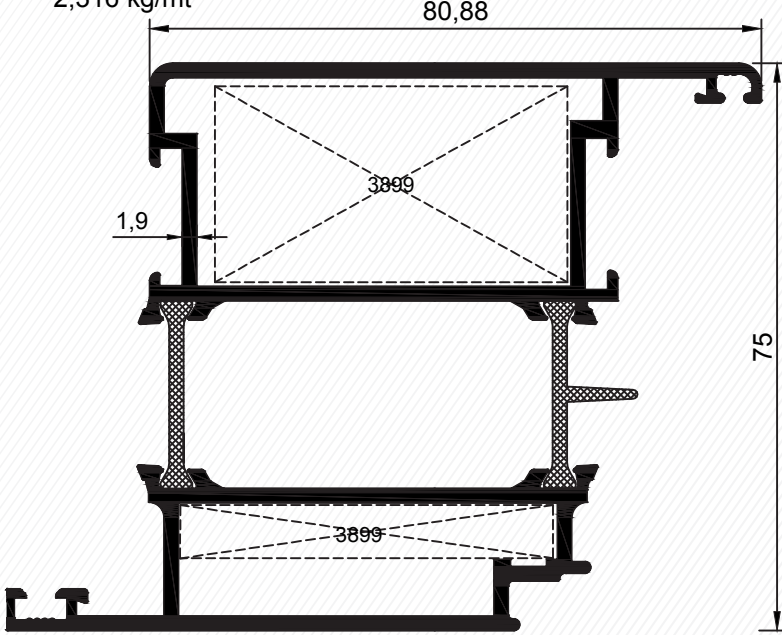
3855-3856
2,316 kg/mt



3855-3856

Dışa Açılım Adaptör Profili - Adapter Profile

3873-3875
1,201 kg/mt

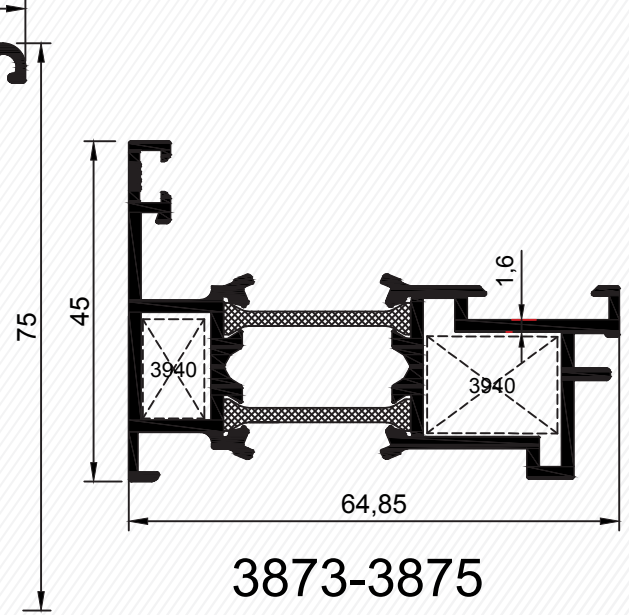

3873-3875

Kod	Ef Kalın.	Ürün Adı	Ağırlığı	Köşe Takozu
3855-3856	1,9 mm	Kanat Profili	2,316 kg/mt	3899-7 mm 3899-27,1 mm
3873-3875	1,9 mm	Adaptör Profili	1,201 kg/mt	3940-8,7 mm 3940-17,7 mm

Dışa Açılım Kapı Kanat - Door Sash Profile

3862-3863
2,389 kg/mt

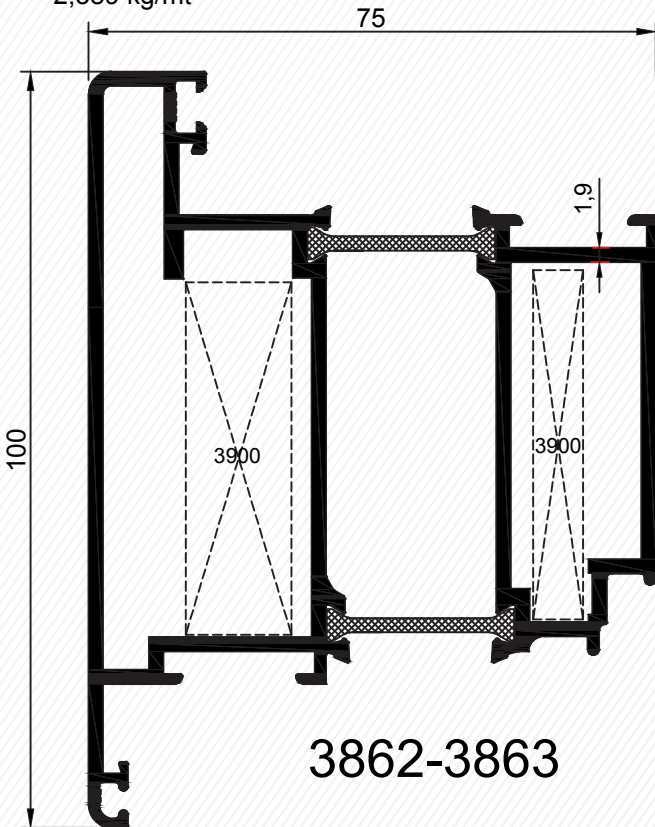

3862-3863

Çift Kanat Adaptör Profili - Adapter Profile

3874-3876
1,465 kg/mt

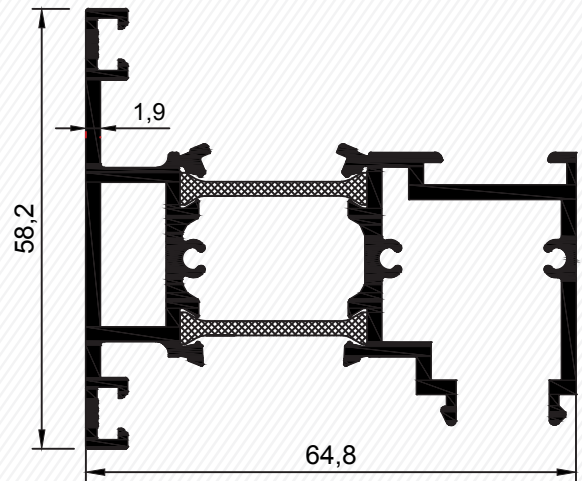

3874-3876

Kod	Ef Kalın.	Ürün Adı	Ağırlığı	Köşe Takozu
3862-3863	1,9 mm	Kanat Profili	2,389 kg/mt	3900-27,1 mm 3900-7,3 mm
3874-3876	1,9 mm	Adaptör Profili	1,465 kg/mt	

Profiller / Profiles

Pivot Adaptör Profili - Adapter Profile
 3935-3936
 1,466 kg/mt

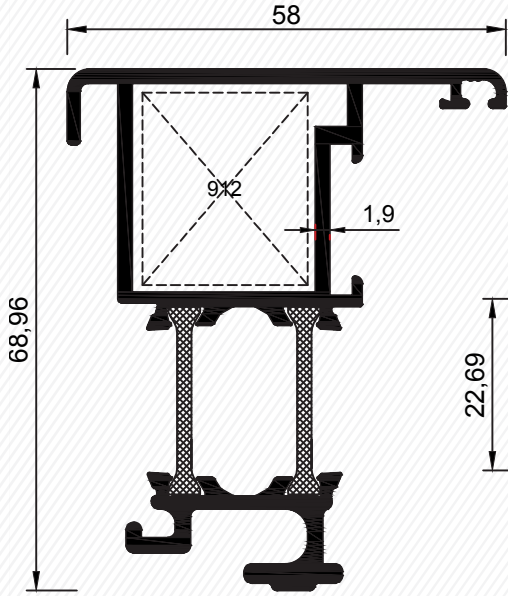

3935-3936

Tek Cam Çıta Profili - Bead Glazing Profile

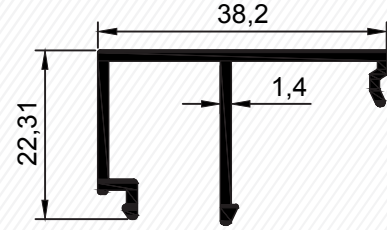

3868
 0,348 kg/mt

Isı Cam Çıta Profili - Bead Glazing Profile

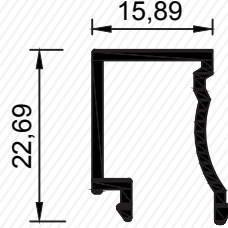

5139
 0,245 kg/mt

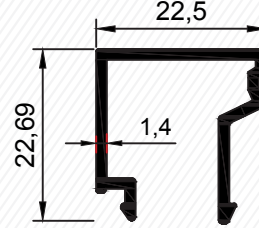

3869
 0,281 kg/mt

Tij Profili - Rod Profile

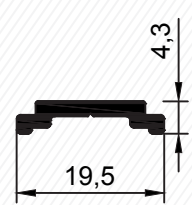

1325
 0,125 kg/mt

Kod	Et Kalın.	Ürün Adı	Ağırlığı	Köşe Takozu
3935-3936	1,6 mm	Pivot Profili	1,466kg/mt	912-27,1 mm

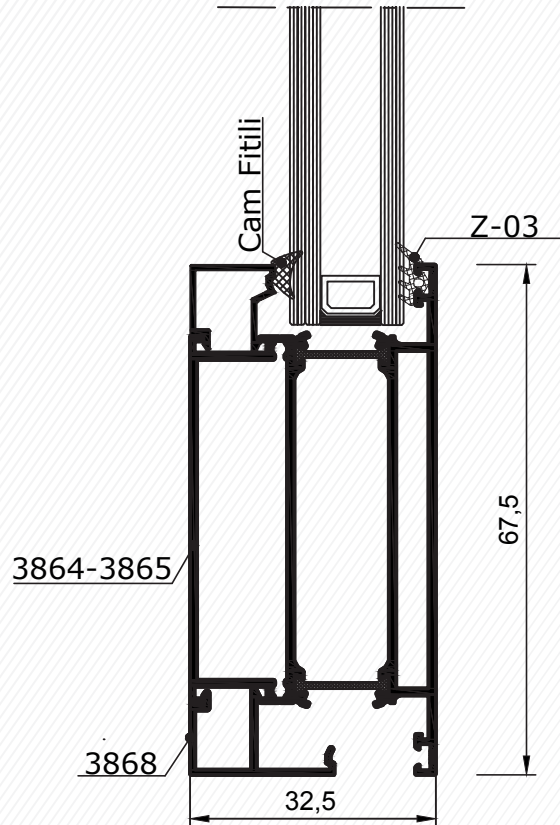
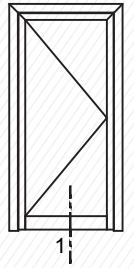
Detaylar / Details

1 DETAYI
 DETAIL

Ölçek: 1:2 / Scale: 1:2

Detaylar / Details

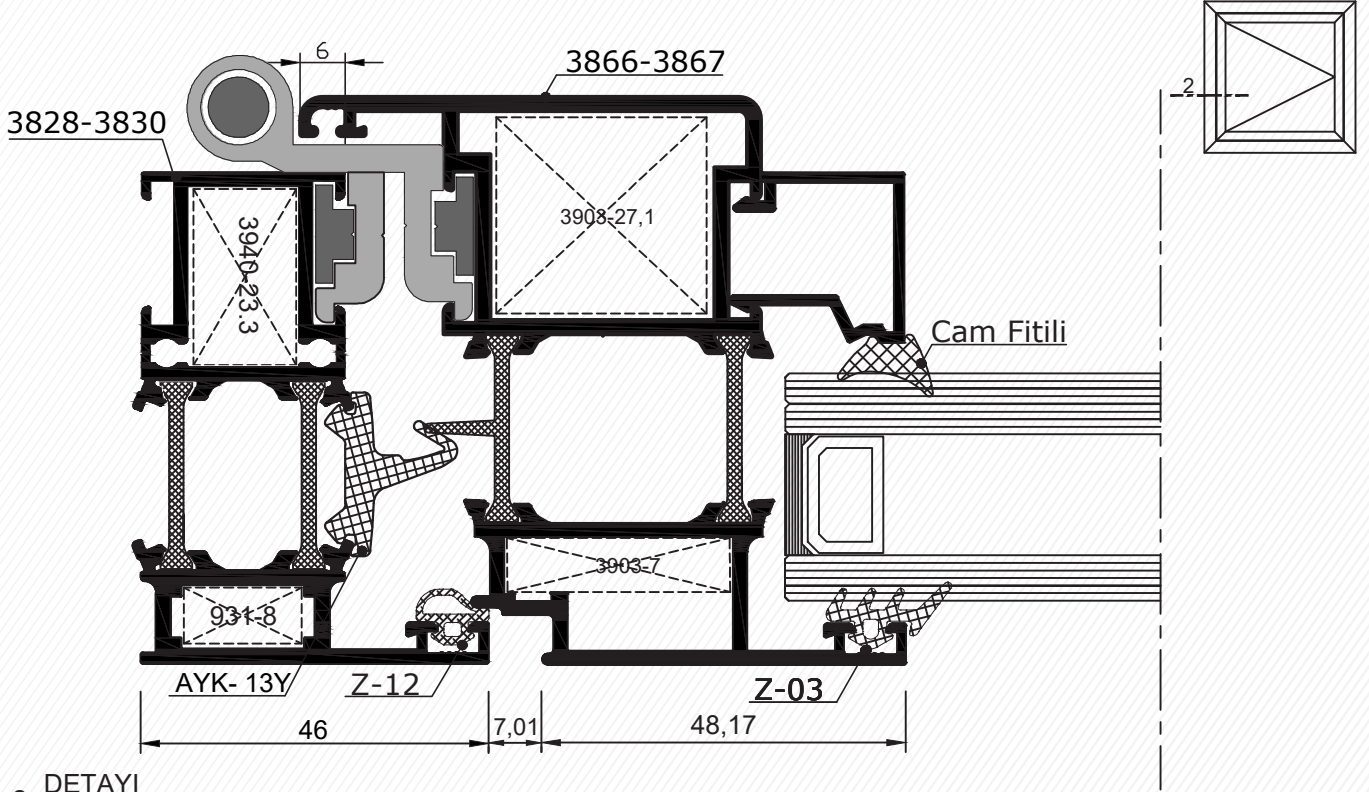

2 DETAYI
DETAIL

Ölçek: 1:1 / Scale: 1:1

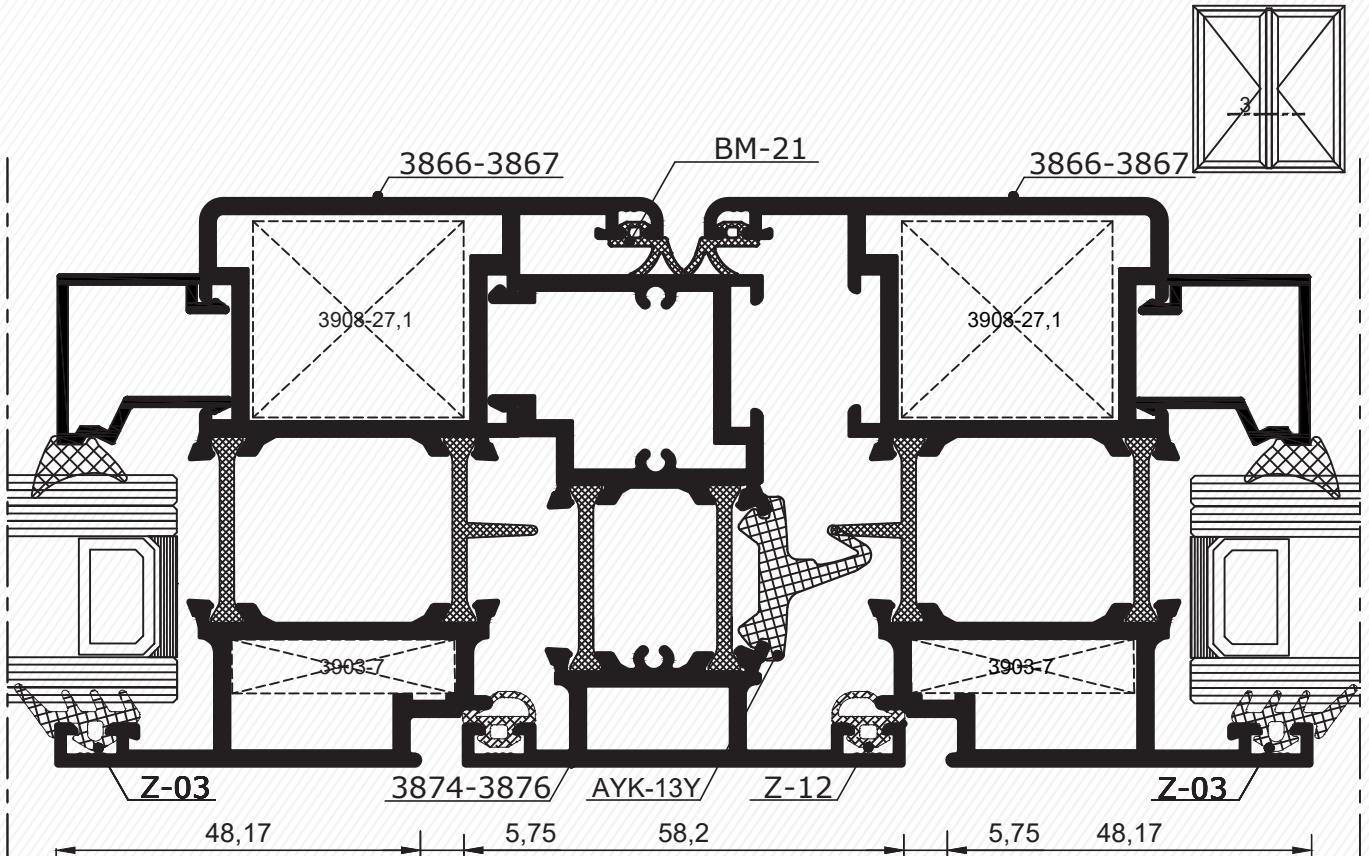

3 DETAYI
DETAIL

Ölçek: 1:1 / Scale: 1:1

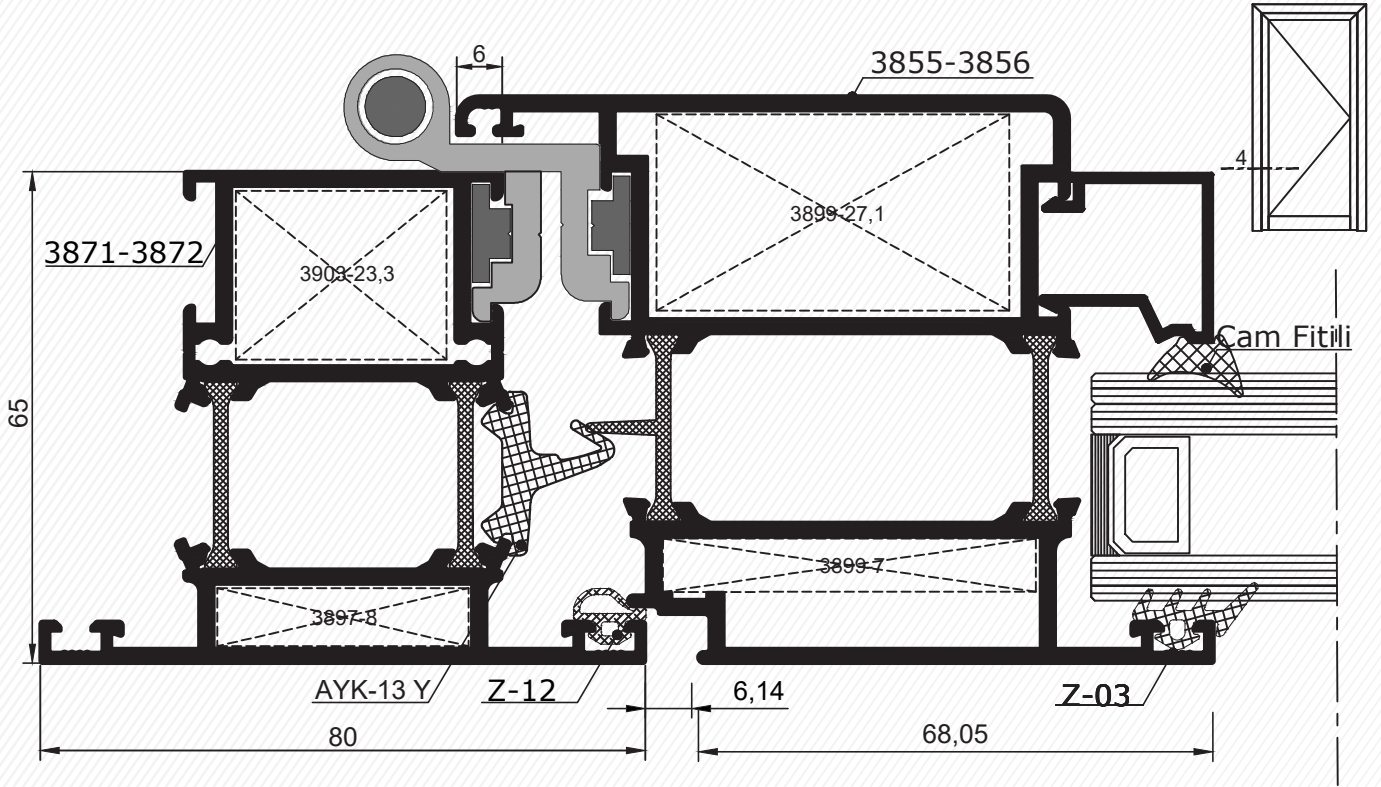
Detaylar / Details

 4
 DETAYI
 DETAIL

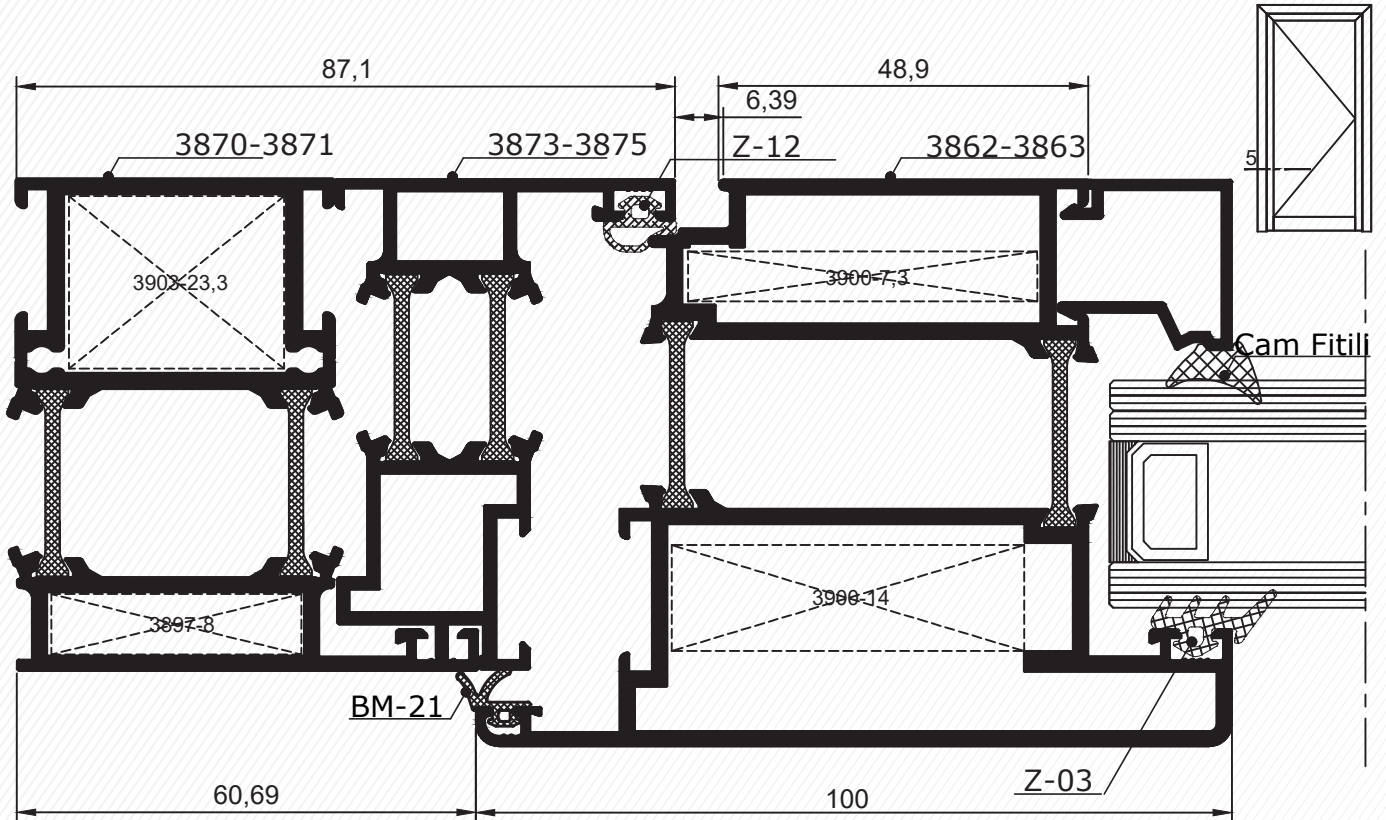
Ölçek: 1:1 / Scale: 1:1

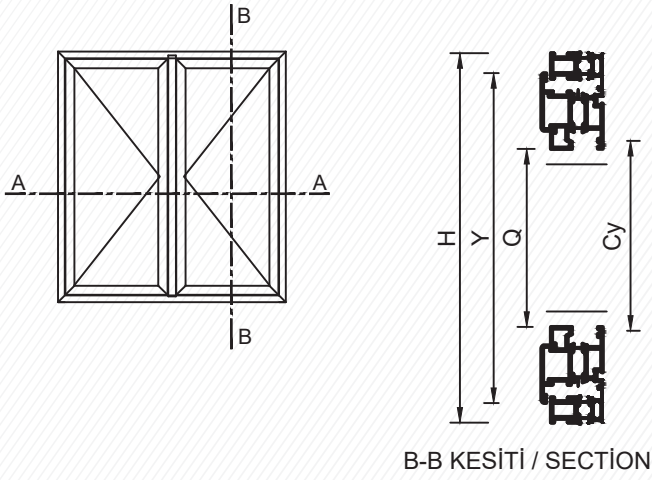

 5
 DETAYI
 DETAIL

Ölçek: 1:1 / Scale: 1:1

Kesim Ölçüsü / Cut Size

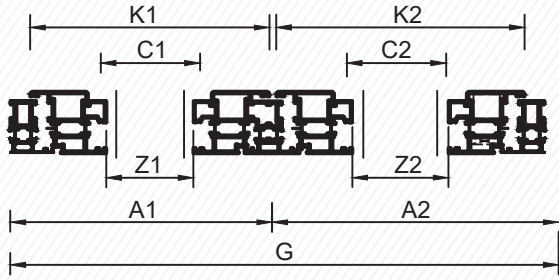

B-B KESİTİ / SECTION



A-A KESİTİ / SECTION

HAREKETLİ ADAPTÖRLÜ PENCERE KESİM FORMÜLÜ

K1 = A1-24,06 mm	G = Kasa Genişliği / Frame Width
K2 = A2-24,15 mm	H = Kasa Yüksekliği / Frame Height
Y = H-42 mm	K = Kanat Genişliği / Sash Width
Z = A1-146 / A2-146	Y = Kanat Yüksekliği / Frame Height
Q = H-202 mm	Z = Çıta Genişliği / Glazing Bead Width
C1 = A1-157	Q = Çıta Yüksekliği / Glazing Bead Height
C2 = A2-157	C = Cam Genişliği / Glass Width
Cy = H-175 mm	Cy = Cam Yüksekliği / Glass Height

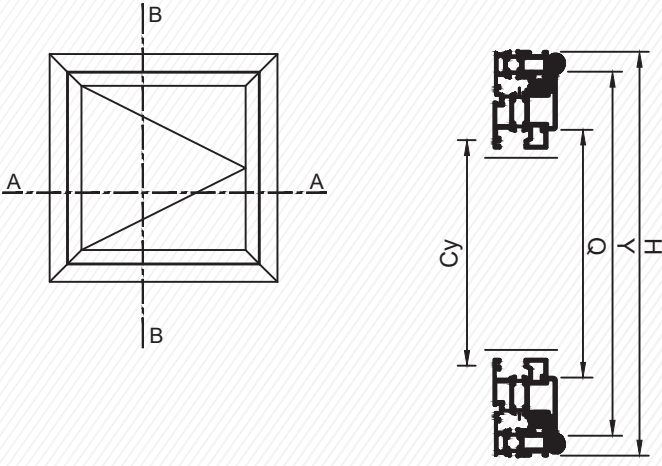

B-B KESİTİ / SECTION

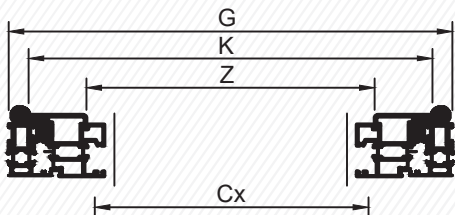









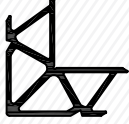

A-A KESİTİ / SECTION







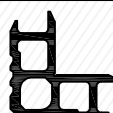



PENCERE KESİM FORMÜLÜ

K = G - 42 mm	G = Kasa Genişliği / Frame Width
Y = H - 42 mm	H = Kasa Yüksekliği / Frame Height
Z = G - 165 mm	K = Kanat Genişliği / Sash Width
Q = H - 202 mm	Y = Kanat Yüksekliği / Frame Height
Cx = G - 175 mm	Z = Çıta Genişliği / Glazing Bead Width
Cy = H - 175 mm	Q = Çıta Yüksekliği / Glazing Bead Height
	Cx = Cam Genişliği / Glass Width
	Cy = Cam Yüksekliği / Glass Height

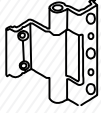
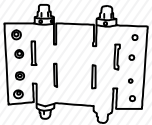

Aksesuarlar / Accessories

Ürün Çizimi Drawing	Ürün Kodu Product No	Ürün Adı Product Name	Kullanıldığı Profiller Profiles Used
	931- 8	Köşe Takozu 15,6 mm Joint Corner	3930-3929
	3940-23,3	Köşe Takozu 13,8 mm Joint Corner	3928
	3897- 8	Köşe Takozu 33,7 mm Joint Corner	3870-3872
	3903-23,3	Köşe Takozu 29 mm Joint Corner	3871
	3940- 7	Köşe Takozu 13,8 mm Joint Corner	3932
	3940-27,1	Köşe Takozu 13,8 mm Joint Corner	3931
	3903- 7	Köşe Takozu 29 mm Joint Corner	3866
	3903-27,1	Köşe Takozu 29 mm Joint Corner	3867
	3899- 7	Köşe Takozu 49 mm Joint Corner	3855
	3899- 27,1	Köşe Takozu 49 mm Joint Corner	3856
	3900- 27,1	Köşe Takozu 46,8 mm Joint Corner	3863
	3900- 7,3	Köşe Takozu 46,8 mm Joint Corner	3862

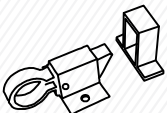
Aksesuarlar / Accessories

Ürün Çizimi Drawing	Ürün Kodu Product No	Ürün Adı Product Name	Kullanıldığı Profiller Profiles Used
	3940- 8,7	Köşe Takoğu 13,8 mm Joint Corner	3873
	3940- 17,7	Köşe Takoğu 13,8 mm Joint Corner	3875
	912-27,10	Köşe Takoğu 23,5 mm Joint Corner	3935
	Z-12	Kasa Bini Fitili 32 gr/mt Brush For Frame	-
	BM-21	Kasa Bini Fitili 28 gr/mt Brush For Sash	-
	AYK-13Y	Orta Tozluğ Fitili 156 gr/mt Middle Brush	-
	Z-03	Cam Fitili 53 gr/mt Brush	-
	AYK-02 AYK-03 AYK-04	Cam Fitili 4 mm 62 gr/mt Cam Fitili 3 mm 74 gr/mt Cam Fitili 2 mm 63 gr/mt Brush For Glass	-
	153-01-320 153-01-321 153-01-322	Menteşe - Hinge 320-Gümüş, 321-Renkli, 322-Beyaz 320-Silver 321-Color 322-White	-
	153-02-034	Çarpma Mentеше Swing Door Hinge	-
	153-01-087 153-01-088 153-01-089	Vasistas Makas Transom Window 087-Gümüş, 088-Renkli, 089-Beyaz 087-Silver, 088-Color, 089-White	-
	153-01-101 153-01-102 153-01-103	Vasistas Çarpma Transom Window Lock 101-Gümüş, 102-Renkli, 103-Beyaz 101-Silver, 102-Color, 103-White	-

Aksesuarlar / Accessories

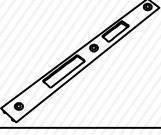
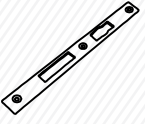
Ürün Çizimi Drawing	Ürün Kodu Product No	Ürün Adı Product Name	Kullanıldığı Profiller Profiles Used
	153-01-055 153-01-056 153-01-057	Eksenel Pencere Kolu Handle For Window 055-Gümüş, 056-Renkli, 057-Beyaz 055-Silver, 056-Color, 057-White	-
	153-01-052 153-01-053 153-01-054	Milenyum Kapı Kolu Handle For Door 052-Gümüş, 053-Renkli, 054-Beyaz 052-Silver, 053-Color, 054-White	-
	153-01-041 153-01-192 153-01-768	Dili Kilit Karşılığı Locking Keeper 041-Gümüş, 192-Renkli, 768-Beyaz 041-Silver, 192-Color, 768-White	-
	153-01-041 153-01-192 153-01-768	Makaralı Kilit Karşılığı Keeper Locking Roller 041-Gümüş, 192-Renkli, 768-Beyaz 041-Silver, 192-Color, 768-White	-