

# ALKOR

ALUMINUM



## YALITIMLI KAPI & PENCERE SİSTEMLERİ







INSULATED DOOR AND WINDOW SYSTEMS

- ALK 5500 T
- ALK 6500 T
- ALK 8800

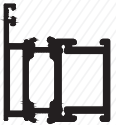

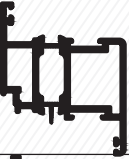
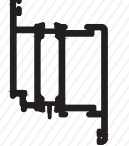
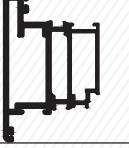

## ALK 5500T



**İçindekiler / Contents**

Profil Profile	Profil Kodu Profile No	Ağırlık (kg/m.) Weight (kg/m.)	X mm.	Y mm.	Jx cm <sup>4</sup>	Jy cm <sup>4</sup>
	3928-3930 Kasa Profili Frame Profile	1,370 kg/m	55 mm	46 mm	16,53	6,47
	3870-3871 Geniş Kasa Profili Frame Profile	1,650 kg/m	55 mm	61 mm	22,17	12,59
	3928-3929 Orta Kayıt Profili Mullion Profile	1,528 kg/m	55 mm	65 mm	17,22	9,54
	3871-3872 Orta Kayıt Profili Mullion Profile	1,788 kg/m	55 mm	80 mm	22,22	22,02
	3865-3865 Orta Kayıt Profili Mullion Profile	2,920 kg/m	55 mm	135 mm	146,39	39,03
	3931-3932 Kanat Profili Sash Profile	1,540 kg/m	65 mm	46 mm	30,61	6,80
	3866-3867 Kanat Profili Sash Profile	1,850 kg/m	65 mm	61 mm	39,70	16,21
	3855-3856 Kanat Profili Sash Profile	2,360 kg/m	65 mm	80 mm	61,36	32,73
	3862-3863 Dışa Açılır Kanat Pr. Sash Profile	2,330 kg/m	65 mm	100 mm	63,05	42,05
	3873-3875 Adaptör Profili Adapter Profile	1,140 kg/m	55 mm	45 mm	12,87	3,92
	3874-3876 Adaptör Profili Adapter Profile	1,440 kg/m	55 mm	58 mm	17,74	8,47

**İçindekiler / Contents**

Profil Profile	Profil Kodu Profile No	Ağırlık (kg/m.) Weight (kg/m.)	X mm.	Y mm.	Jx cm <sup>4</sup>	Jy cm <sup>4</sup>
	3935-3936 Kasa Profili Frame Profile	1,410 kg/m	58 mm	58 mm	21,59	9,24
	3868 Çıta Profili Bead Glazing Pr.	0,348 kg/m	38 mm	22 mm	----	----
	3869 Çıta Profili Bead Glazing Pr.	0,281 kg/m	22 mm	22 mm	----	----
	5139 Çıta Profili Bead Glazing Pr.	0,245 kg/m	15 mm	22 mm	----	----
	1325 Tij Profili Rod Profile	0,125 kg/m	19,5 mm	4,3 mm	----	----

Profiller / Profiles

Kasa Profili - Frame Profile

3928-3930  
1,370 kg/mt

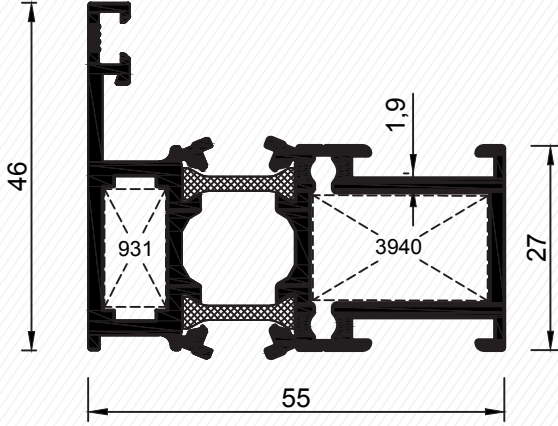

3928-3930

Geniş Kasa Profili - Frame Profile

3870-3871  
1,650 kg/mt

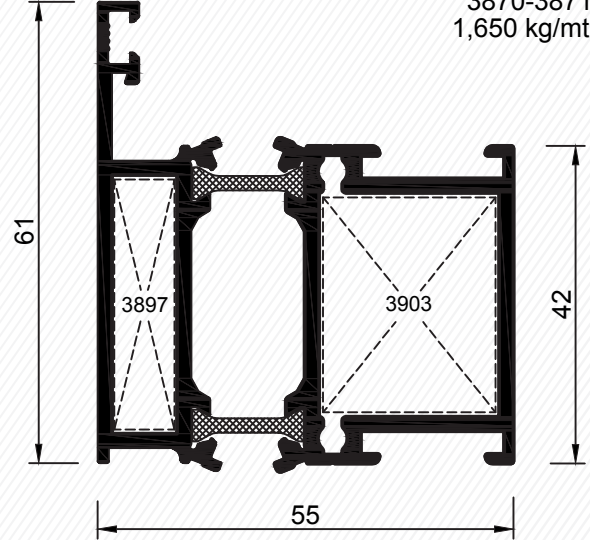

3870-3871

Kod	Et Kalın.	Ürün Adı	Ağırlığı	Köşe Takozu
3930-3928	1,9 mm	Kasa Profili	1,370 kg/mt	931-8 mm 3940-23,3 mm
3870-3871	1,9 mm	Kasa Profili	1,650 kg/mt	3897-8 mm 3903-23,3 mm

Orta Kayıt Profili - Mullion Profiles

3928-3929  
1,528 kg/mt

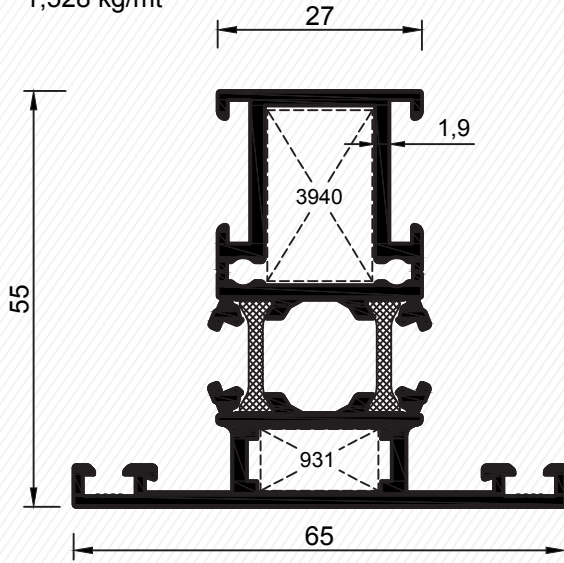

3928-3929

Geniş Orta Kayıt Profili - Mullion Profile

3871-3872  
1,788 kg/mt

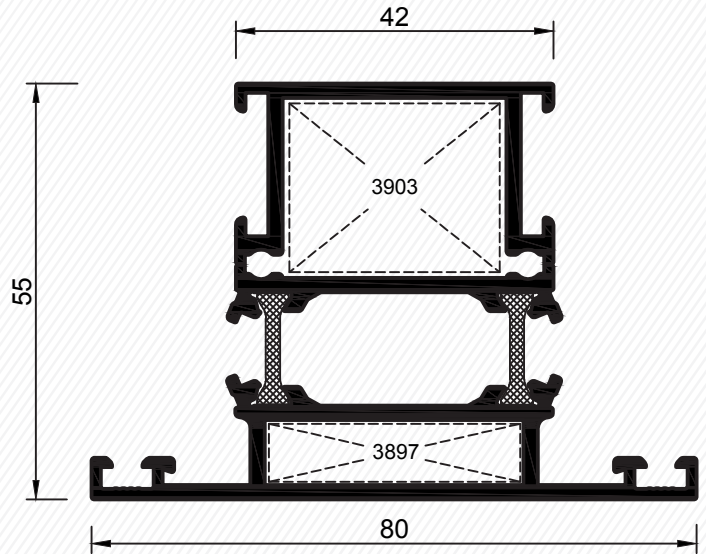

3871-3872

Kod	Et Kalın.	Ürün Adı	Ağırlığı	Köşe Takozu
3929-3928	1,9 mm	"T" Profili	1,528 kg/mt	931-8 mm 3940-23,3 mm
3872-3871	1,9 mm	"T" Profili	1,788 kg/mt	3897-8 mm 3903-23,3 mm

**Profiller / Profiles**

Duble Orta Kayıt Profili - Double Mullion Profile

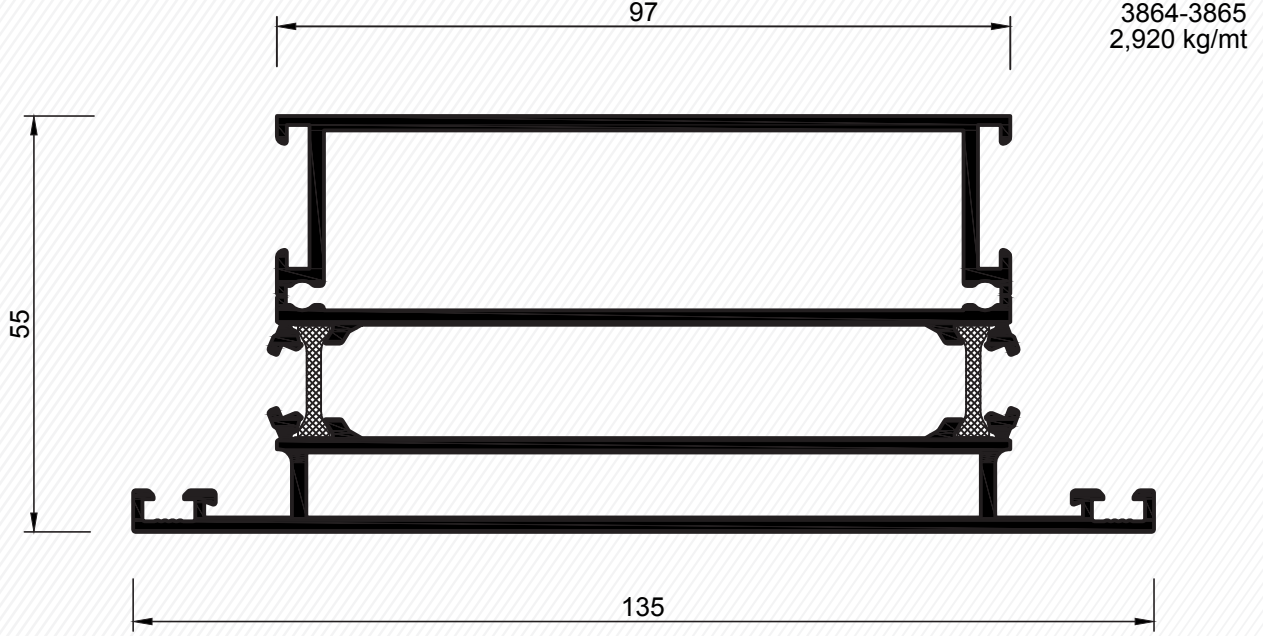
 3864-3865  
 2,920 kg/mt

**3864-3865**

Kod	Et Kalın.	Ürün Adı	Ağırlığı
3864-3865	1,9 mm	T Profili	2,920 kg/mt

Kanat Profili - Sash Profile

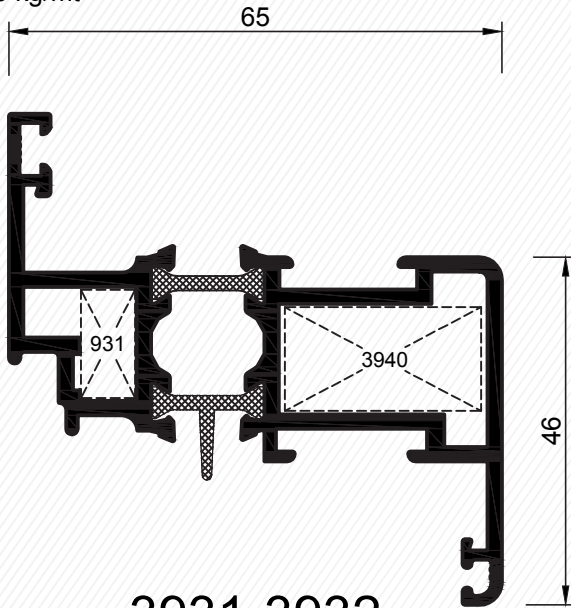
 3931-3932  
 1,540 kg/mt

**3931-3932**

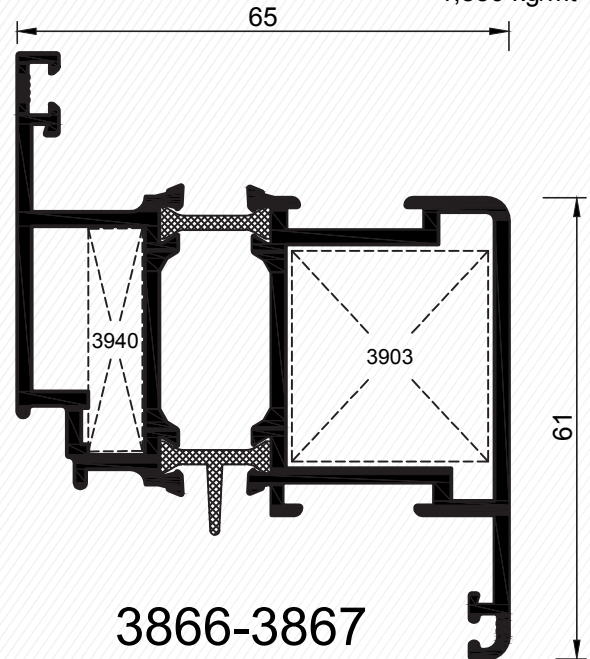
Geniş Kanat Profili - Sash Profile

 3866-3867  
 1,850 kg/mt

**3866-3867**

Kod	Et Kalın.	Ürün Adı	Ağırlığı	Köşe Takozu
3931-3932	1,9 mm	Kanat Profili	1,540 kg/mt	3940-7 mm 3940-27,1 mm
3866-3867	1,9 mm	Kanat Profili	1,850 kg/mt	3940-7 mm 3903-27,1 mm

Profiller / Profiles

Kapı Kanat Profili - Door Sash Profile

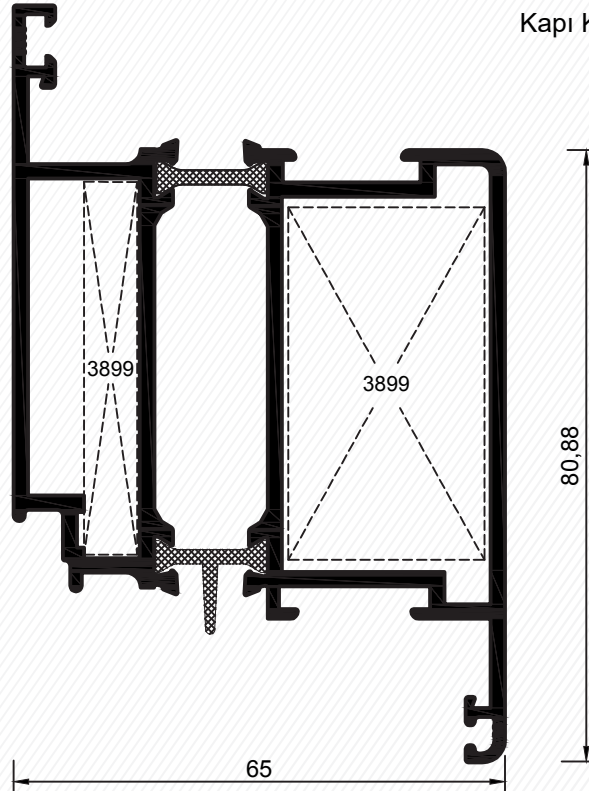
3855-3856  
2,360 kg/mt



3855-3856

Kod	Et Kalın.	Ürün Adı	Ağırlığı	Köşe Takozu
3855-3856	1,9 mm	Kanat Profili	2,360 kg/mt	3899-7 mm 3899-27,1 mm

Dışa Açılım Kapı Kanat Profili - Door Sash Profile  
3862-3863  
2,330 kg/mt

Dışa Açılım Adaptör Profili - Adapter Profile

3973-3875  
1,140 kg/mt

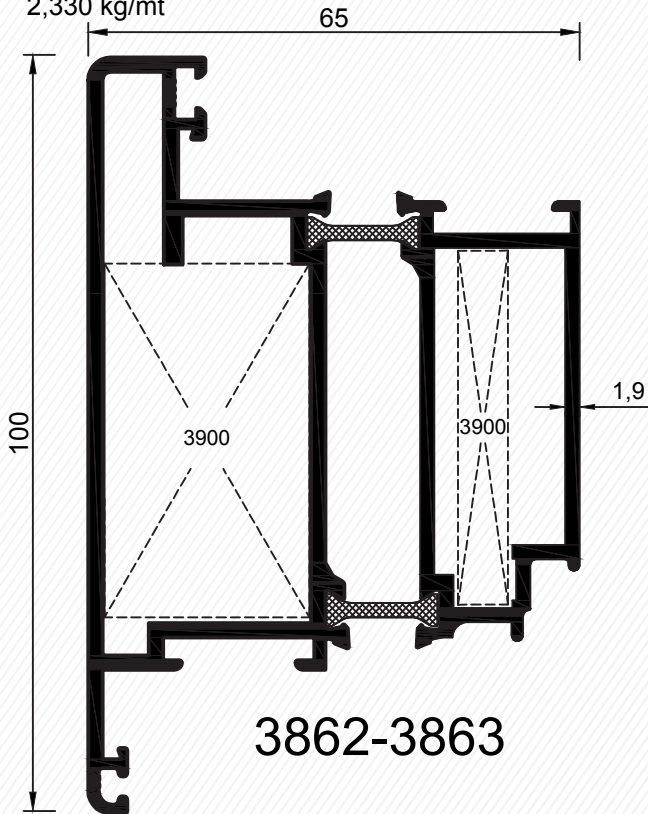

3862-3863

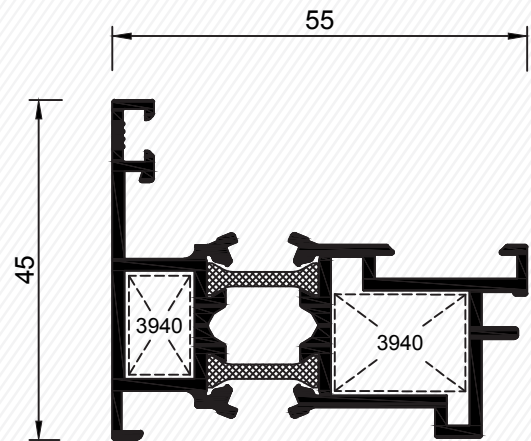

3873-3875

Kod	Et Kalın.	Ürün Adı	Ağırlığı	Köşe Takozu
3862-3863	1,9 mm	Kanat Profili	2,330 kg/mt	3900-27,1 mm 3900-7,3 mm
3873-3875	1,6 mm	Adaptör Profili	1,140 kg/mt	3940-8,7 mm 3940-17,7 mm

**Profiller / Profiles**

Çift Kanat Adaptör Profili - Adapter Profile

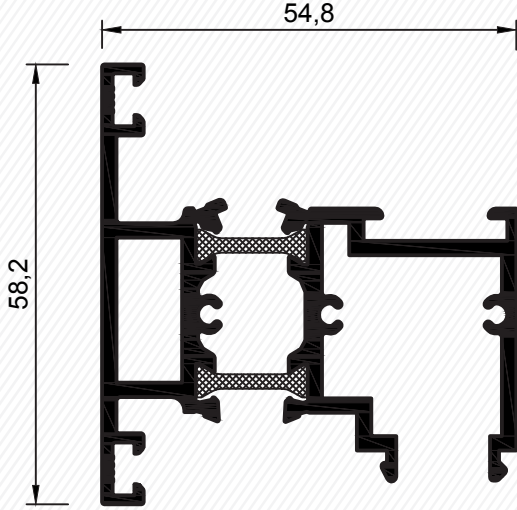
 3874-3876  
 1,440 kg/mt

**3874-3876**

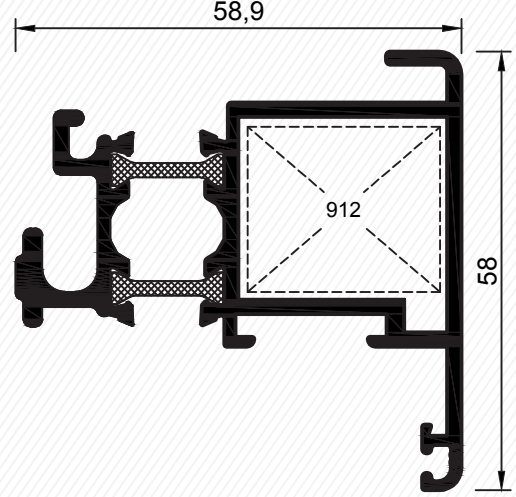
Pivot Adaptör Profili - Adapter Profile

 3935-3936  
 1,410 kg/mt

**3935-3936**

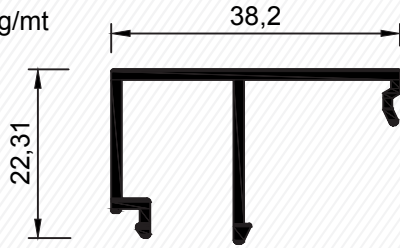
Kod	Et Kalın.	Ürün Adı	Ağırlığı	Köşe Takozu
3935-3936	1,6 mm	Pivot Profili	1,410 kg/mt	912-27,1 mm
3874-3876	1,9 mm	Adaptör Profili	1,440 kg/mt	

Tek Cam Çıta Profili - Bead Glazing Profile

 3868  
 0,348 kg/mt

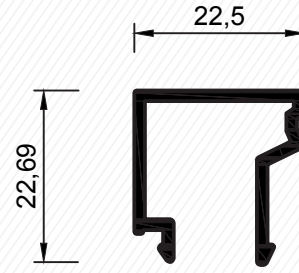
**3868**

Isı Cam Çıta Profili - Bead Glazing Profile

 3869  
 0,281 kg/mt

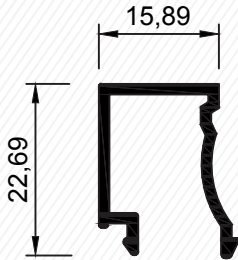
**3869**

Isı Cam Çıta Profili - Bead Glazing Profile

 5139  
 0,245 kg/mt

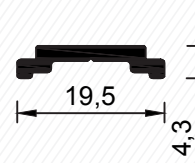
**5139**

Tij Profili - Slide Profile



**1325**  
 (0,125 kg/mt)

Kod	Et Kalın.	Ürün Adı	Ağırlığı
5139	1,6 mm	Çıta Profili	0,245 kg/mt
3868	1,4 mm	Çıta Profili	0,348 kg/mt
3869	1,4 mm	Çıta Profili	0,281 kg/mt
1325		Tij Profili	0,125 kg/mt

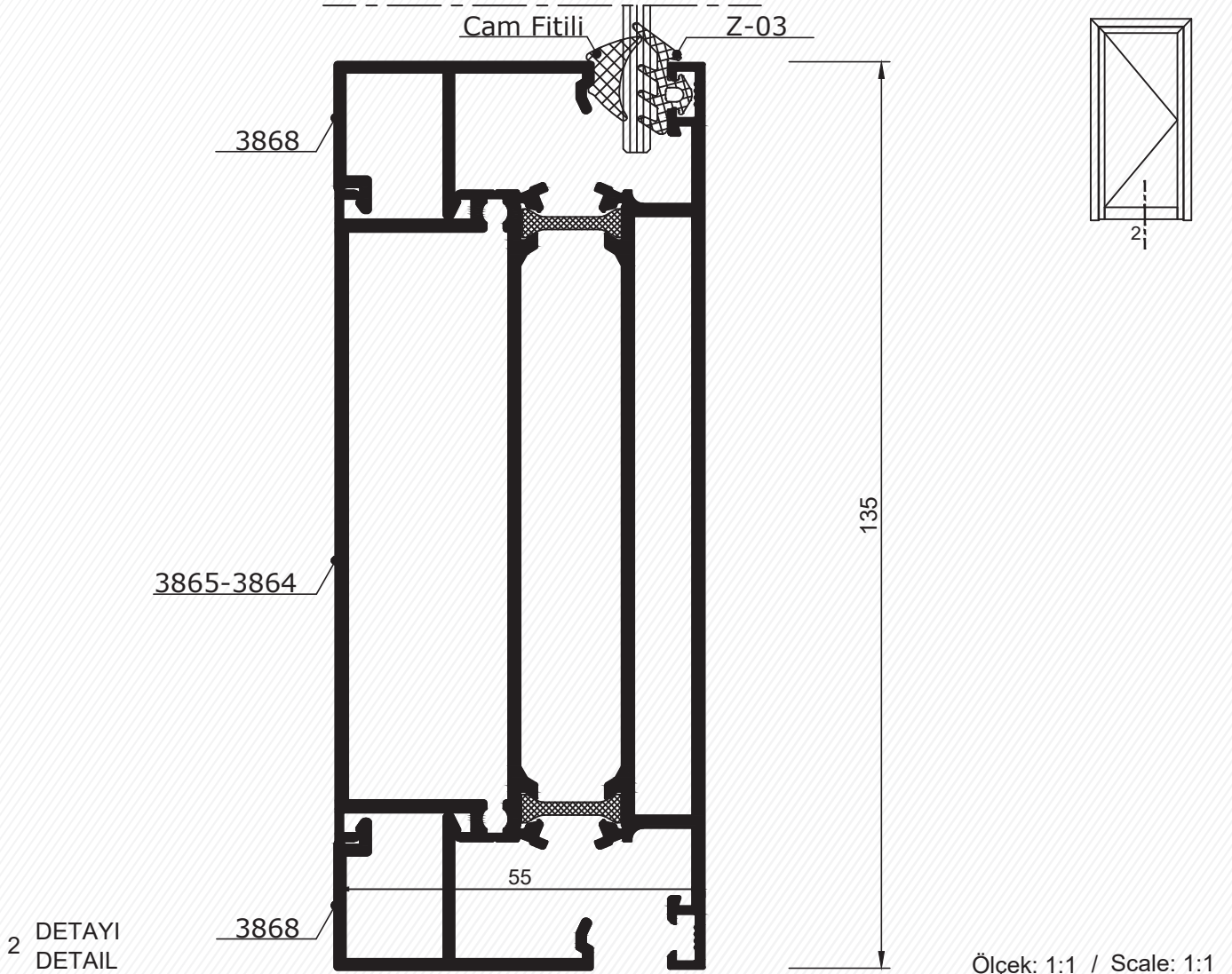
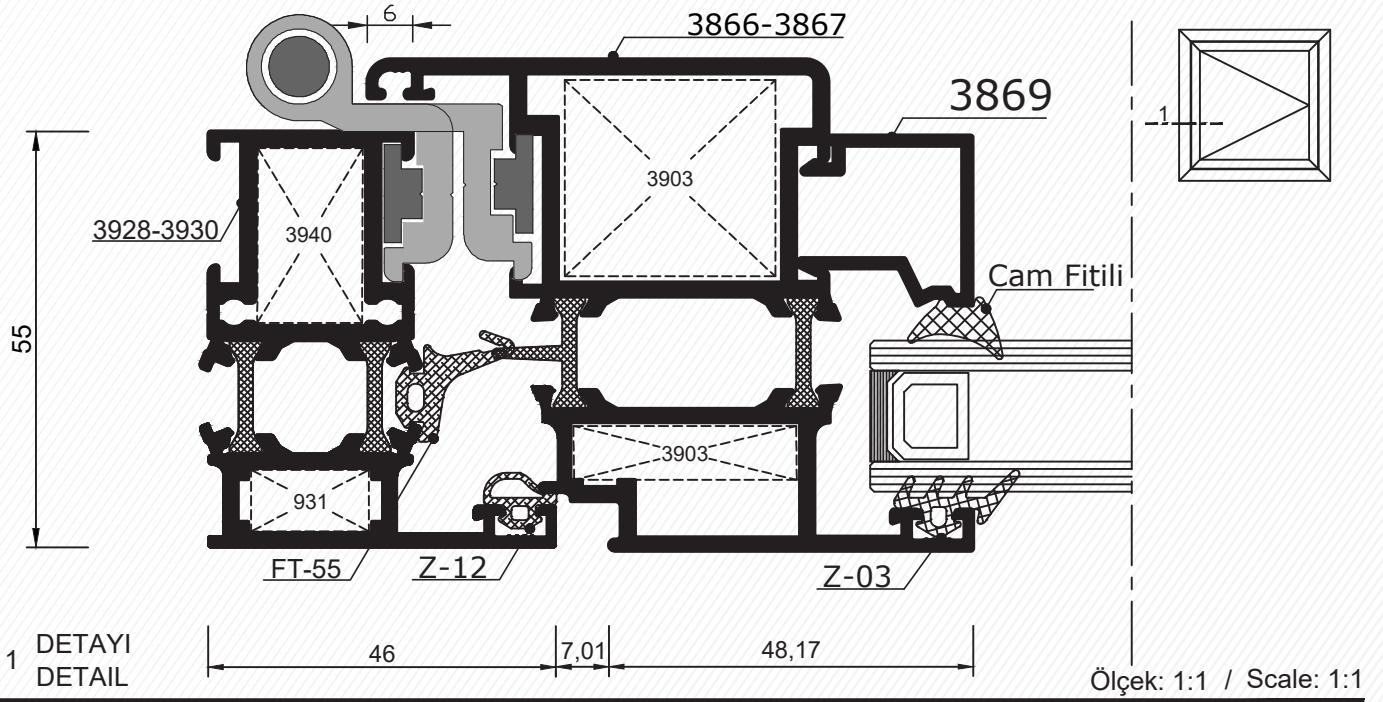

Detaylar / Details

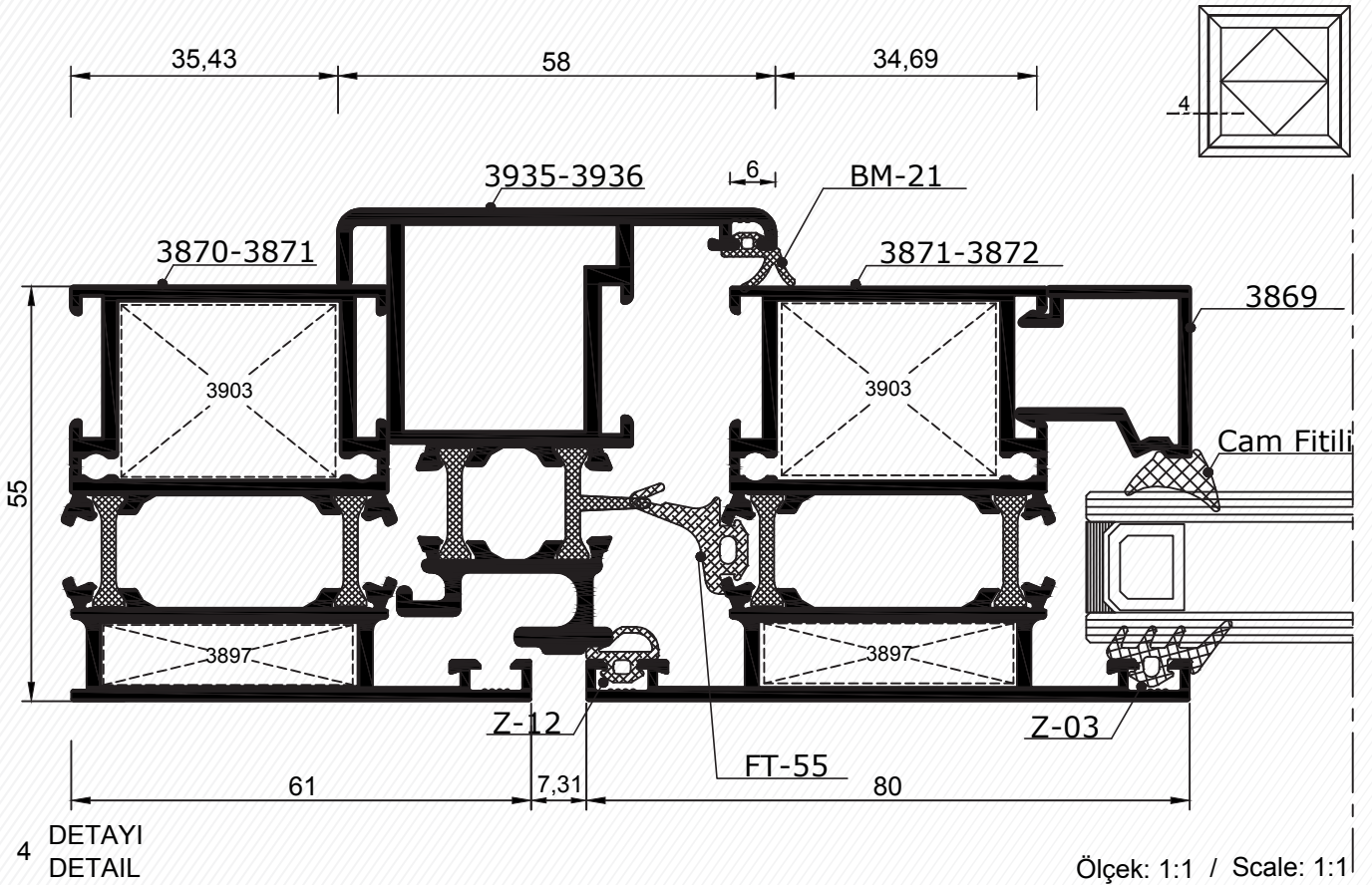
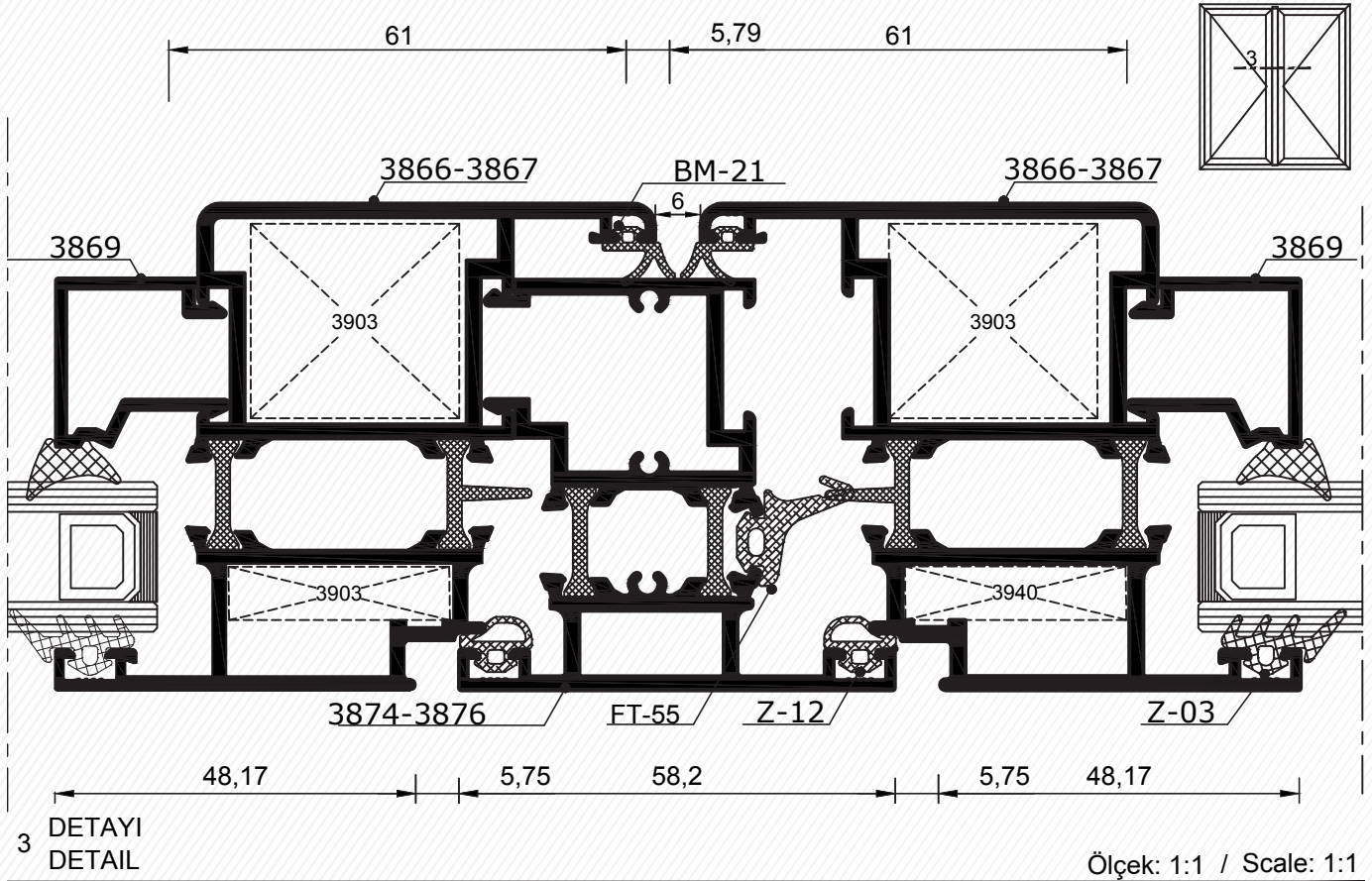

**Detaylar / Details**

Detaylar / Details

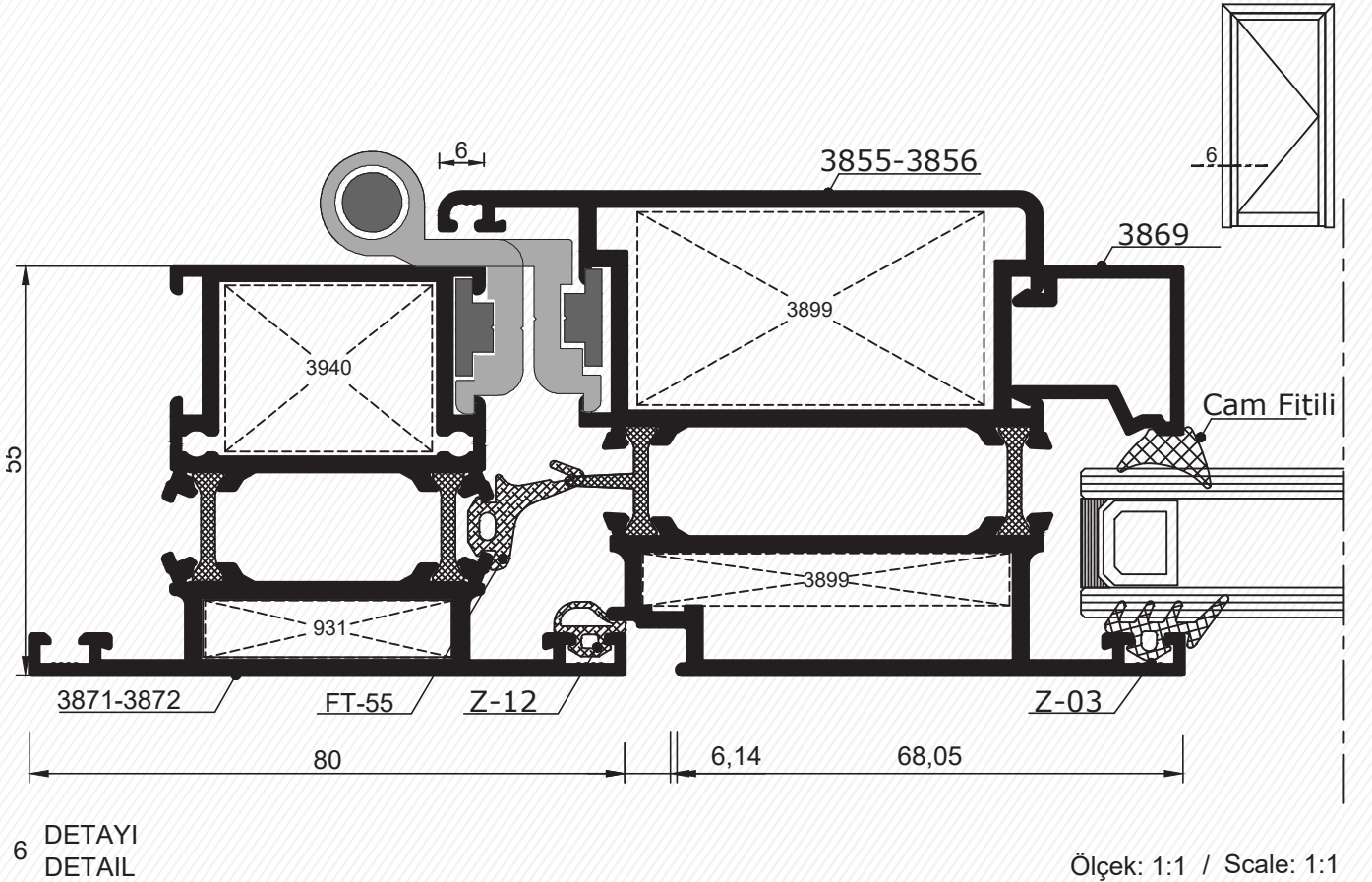
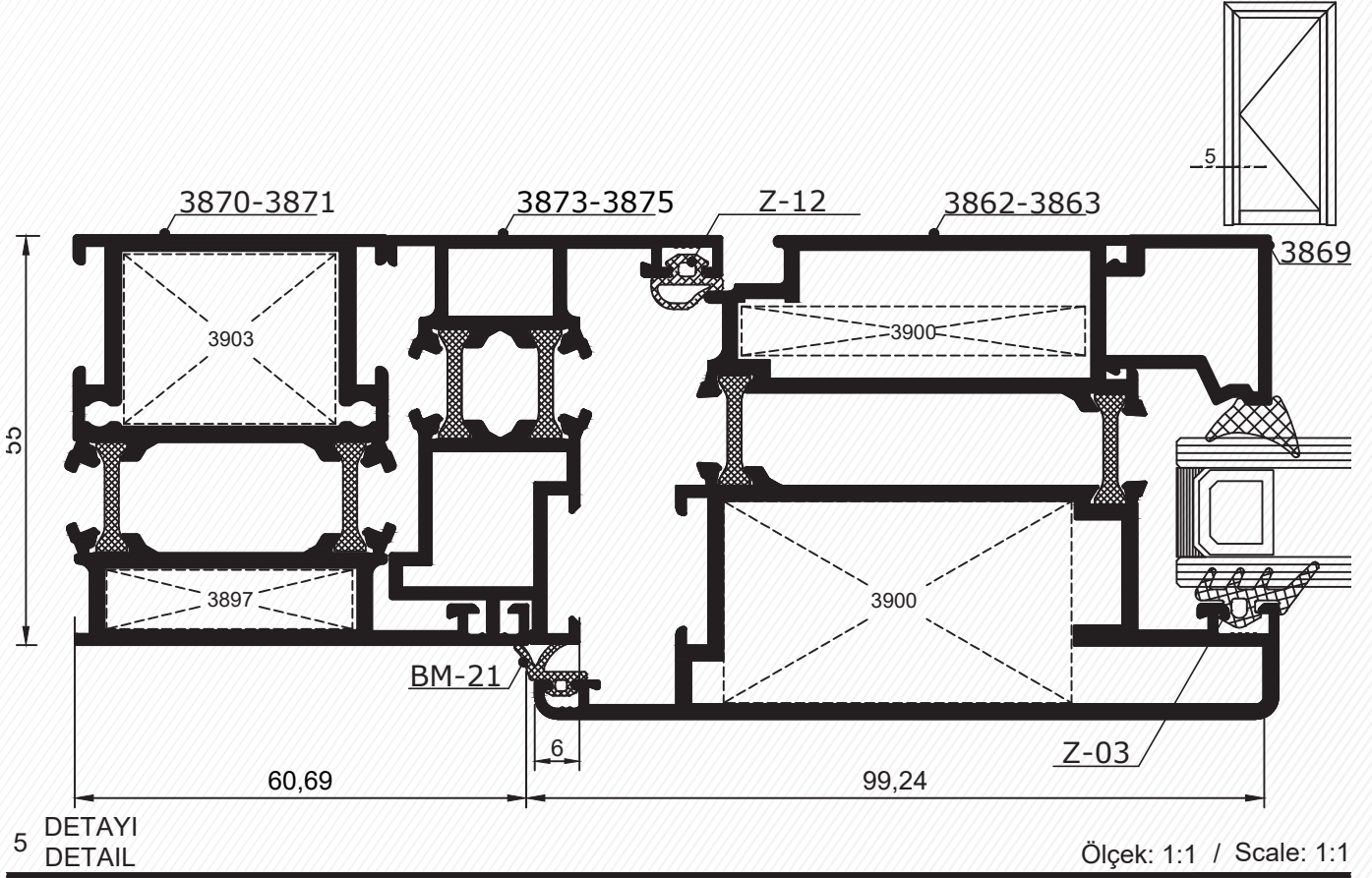

## Kesim Ölçüsü / Cut Size

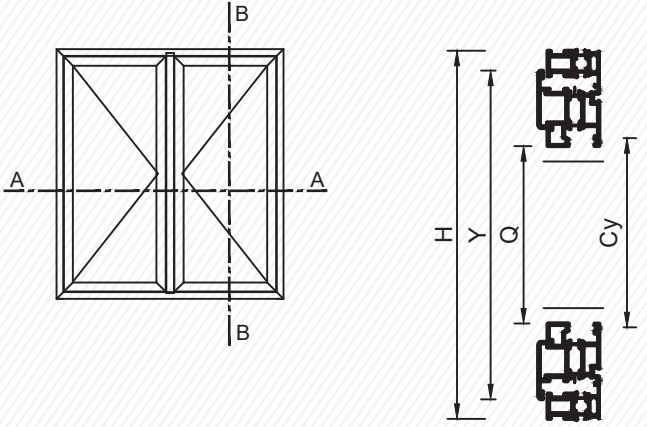

B-B KESİTİ / SECTION

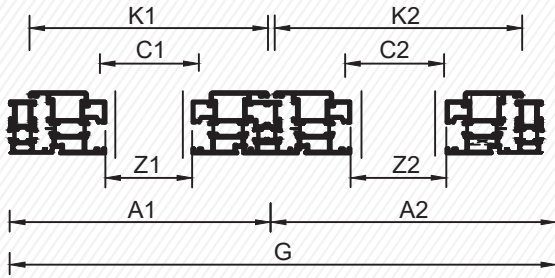

A-A KESİTİ / SECTION

### HAREKETLİ ADAPTÖRLÜ PENCERE KESİM FORMÜLÜ

K1 = A1-24,06 mm	G = Kasa Genişliği / Frame Width
K2 = A2-24,15 mm	H = Kasa Yüksekliği / Frame Height
Y = H-42 mm	K = Kanat Genişliği / Sash Width
Z = A1-146 / A2-146	Y = Kanat Yüksekliği / Frame Height
Q = H-202 mm	Z = Çıta Genişliği / Glazing Bead Width
C1 = A1-157	Q = Çıta Yüksekliği / Glazing Bead Height
C2 = A2-157	C = Cam Genişliği / Glass Width
Cy = H-175 mm	Cy = Cam Yüksekliği / Glass Height

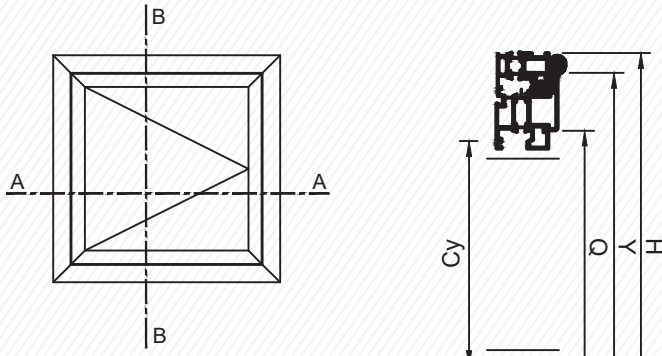

B-B KESİTİ / SECTION





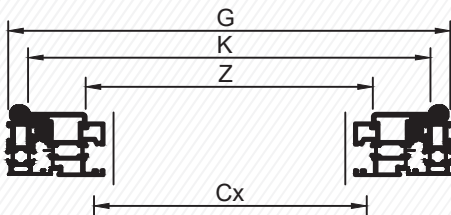







### PENCERE KESİM FORMÜLÜ

K = G - 42 mm	G = Kasa Genişliği / Frame Width
Y = H - 42 mm	H = Kasa Yüksekliği / Frame Height
Z = G - 165 mm	K = Kanat Genişliği / Sash Width
Q = H - 202 mm	Y = Kanat Yüksekliği / Frame Height
Cx = G - 175 mm	Z = Çıta Genişliği / Glazing Bead Width
Cy = H - 175 mm	Q = Çıta Yüksekliği / Glazing Bead Height
	Cx = Cam Genişliği / Glass Width
	Cy = Cam Yüksekliği / Glass Height













A-A KESİTİ / SECTION

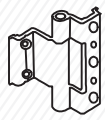
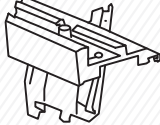
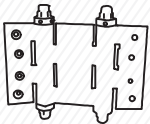

**Aksesuarlar / Accessories**

Ürün Çizimi Drawing	Ürün Kodu Product No	Ürün Adı Product Name	Kullanıldığı Profiller Profiles Used
	931- 8	Köşe Takozu 15,6 mm Joint Corner	3930-3929
	3940-23,3	Köşe Takozu 13,8 mm Joint Corner	3928
	3897- 8	Köşe Takozu 33,7 mm Joint Corner	3870-3872
	3903-23,3	Köşe Takozu 29 mm Joint Corner	3871
	3940- 7	Köşe Takozu 13,8 mm Joint Corner	3932
	3940-27,1	Köşe Takozu 13,8 mm Joint Corner	3931
	3903- 7	Köşe Takozu 29 mm Joint Corner	3866
	3903-27,1	Köşe Takozu 29 mm Joint Corner	3867
	3899- 7	Köşe Takozu 49 mm Joint Corner	3855
	3899- 27,1	Köşe Takozu 49 mm Joint Corner	3856
	3900- 27,1	Köşe Takozu 46,8 mm Joint Corner	3863
	3900- 7,3	Köşe Takozu 46,8 mm Joint Corner	3862

### Aksesuarlar / Accessories

Ürün Çizimi Drawing	Ürün Kodu Product No	Ürün Adı Product Name	Kullanıldığı Profiller Profiles Used
	3940- 8,7	Köşe Takozu 13,8 mm Joint Corner	3873
	3940- 17,7	Köşe Takozu 13,8 mm Joint Corner	3875
	912-27,10	Köşe Takozu 23,5 mm Joint Corner	3935
	Z-12	Kasa Bini Fiteli 32 gr/mt Brush For Frame	-
	BM-21	Kasa Bini Fiteli 28 gr/mt Brush For Sash	-
	FT-55	Orta Tozluk Fiteli 110 gr/mt Middle Brush	-
	Z-03	Cam Fiteli 53 gr/mt Brush	-
	AYK-02 AYK-03 AYK-04	Cam Fiteli 4 mm 62 gr/mt Cam Fiteli 3 mm 74 gr/mt Cam Fiteli 2 mm 63 gr/mt Brush For Glass	-
	153-01-320 153-01-321 153-01-322	Menteşe - Hinge 320-Gümüş, 321-Renkli, 322-Beyaz 320-Silver 321-Color 322-White	-
	153-01-260 153-01-261 153-02-097	Pivot Mentşe Pivot Hinge 260-Gümüş, 261-Renkli, 097-Beyaz 260-Silver, 261-Color, 097-White	-
	153-02-034	Çarpma Mentşe Swing Door Hinge	-
	153-01-087 153-01-088 153-01-089	Vasistas Makas Transom Window 087-Gümüş, 088-Renkli, 089-Beyaz 087-Silver, 088-Color, 089-White	-

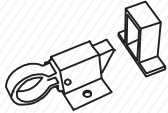
**Aksesuarlar / Accessories**

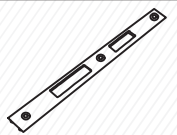
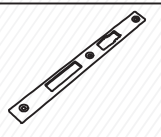
Ürün Çizimi Drawing	Ürün Kodu Product No	Ürün Adı Product Name	Kullanıldığı Profiller Profiles Used
	153-01-101 153-01-102 153-01-103	Vasistas Çarpma Transom Window Lock 101-Gümüş, 102-Renkli, 103-Beyaz 101-Silver, 102-Color, 103-White	-
	153-01-055 153-01-056 153-01-057	Eksenel Pencere Kolu Handle For Window 055-Gümüş, 056-Renkli, 057-Beyaz 055-Silver, 056-Color, 057-White	-
	153-01-052 153-01-053 153-01-054	Milenyum Kapı Kolu Handle For Door 052-Gümüş, 053-Renkli, 054-Beyaz 052-Silver, 053-Color, 054-White	-
	153-01-041 153-01-192 153-01-768	Dili Kilit Karşılığı Locking Keeper 041-Gümüş, 192-Renkli, 768-Beyaz 041-Silver, 192-Color, 768-White	-
	153-01-041 153-01-192 153-01-768	Makaralı Kilit Karşılığı Keeper Locking Roller 041-Gümüş, 192-Renkli, 768-Beyaz 041-Silver, 192-Color, 768-White	-