



YARDIMCI PROFİLLER AUXILIARY PROFILES

- **KÖŞE TAKOZLARI** / CORNER WEDGES
- **BAGLANTI TAKOZLARI** / CONNECTION WEDGES
- **PERVAZ PROFİLLERİ** / SIDE PROFILES
- **LAMBRI,DAMLALIK** / PANEL, DROPPER

PERVAZ PROFİLLERİ

SIDE PROFILES

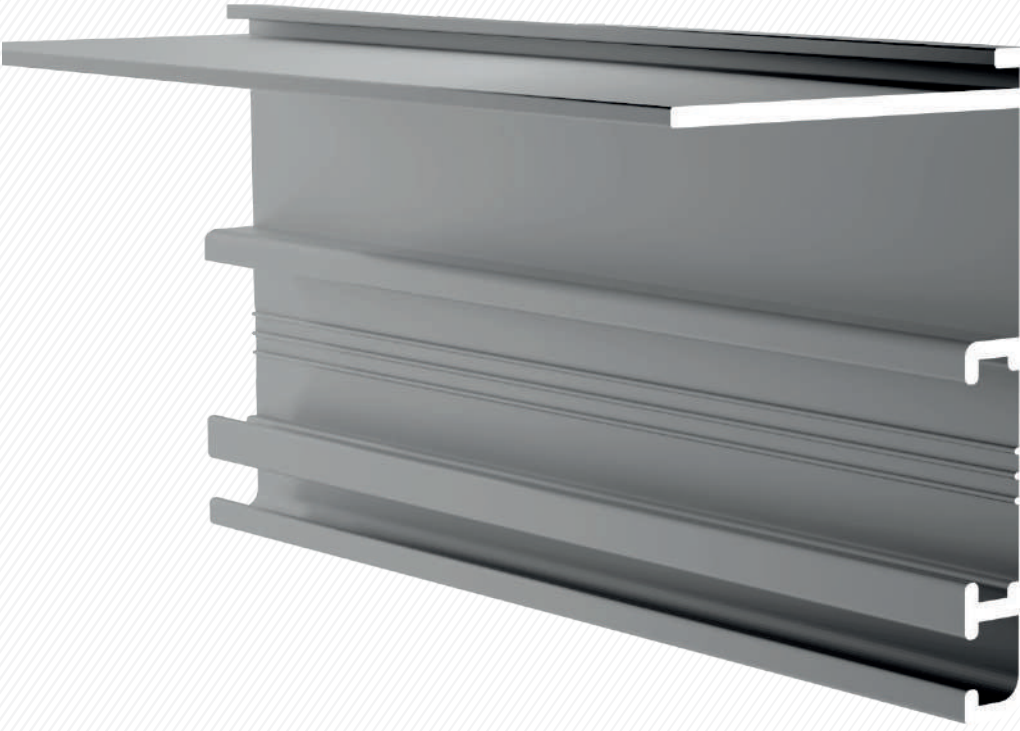

Profiller / Profiles

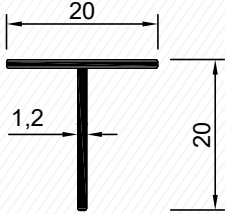

102

0,126 kg/m

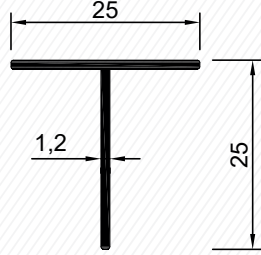

103

0,158 kg/m

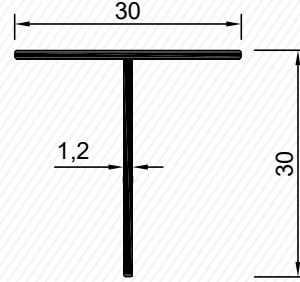

104

0,191 kg/m

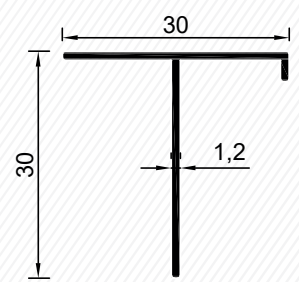

2166

0,199 kg/m

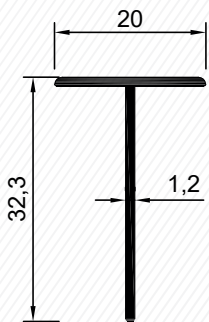

140

0,165 kg/m

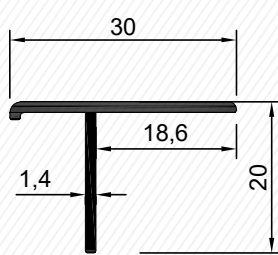

1306

0,186 kg/m

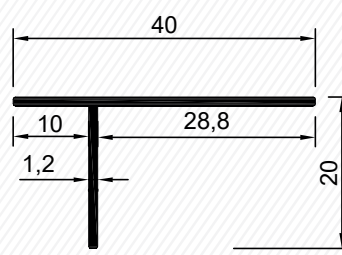

1331

0,191 kg/m

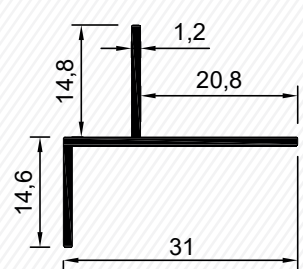

1355

0,192 kg/m

Profiller / Profiles

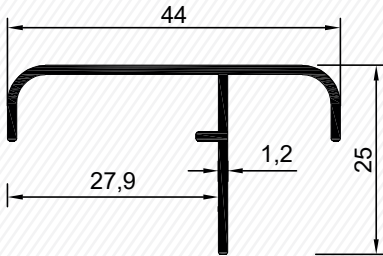

1385

0,274 kg/m

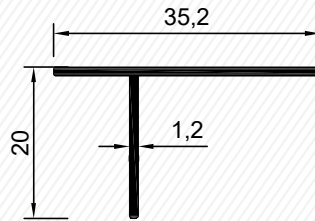

463

0,176 kg/m

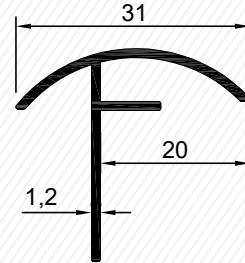

2189

0,222 kg/m

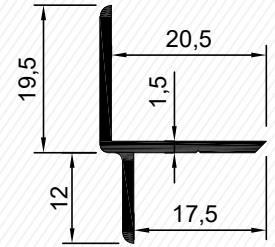

3553

0,206 kg/m

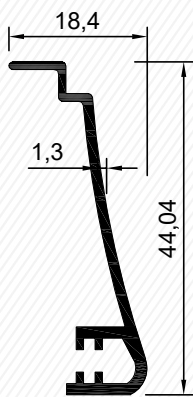

5351

0,265 kg/m

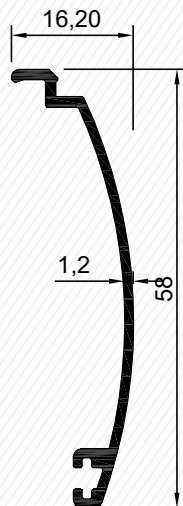

5617

0,266 kg/m

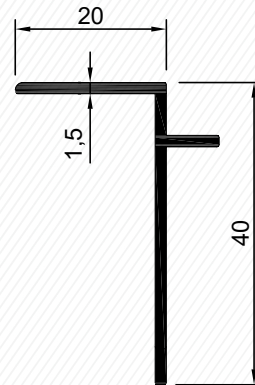

670

0,265 kg/m

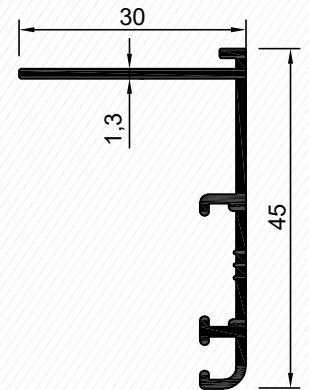

6433

0,335 kg/m