

# ALKOR

ALUMINUM



## YALITIMLI KAPI & PENCERE SİSTEMLERİ





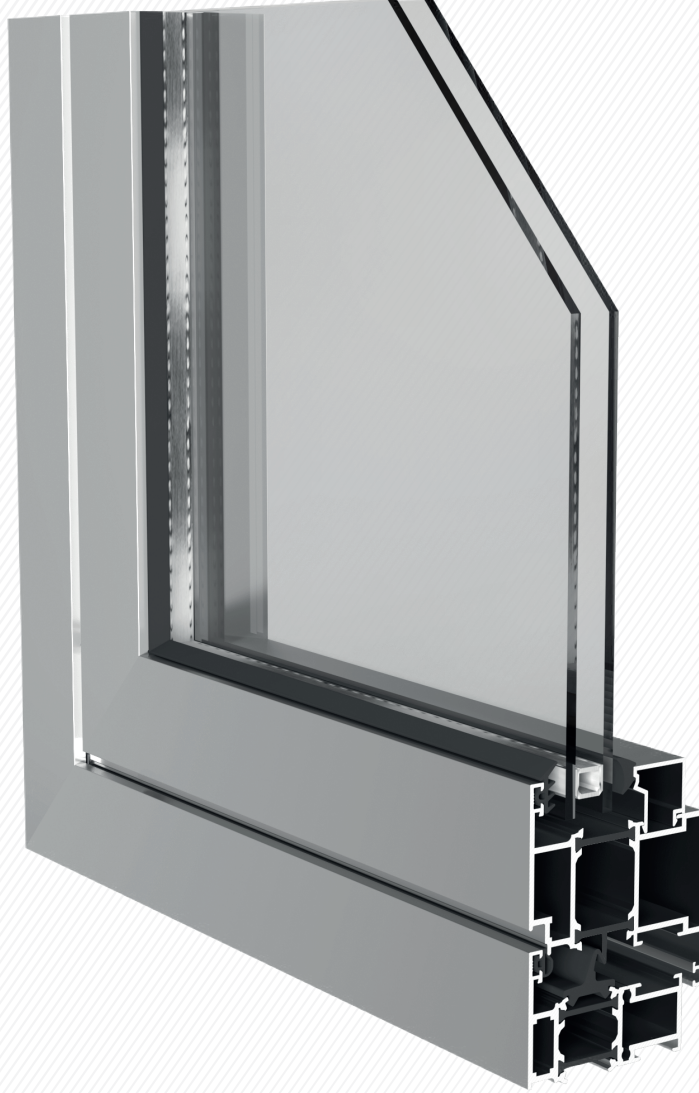

INSULATED DOOR AND WINDOW SYSTEMS

- ALK 5500 T / ALK 5500 T
- ALK 6500 T / ALK 6500 T
- ALK 8800 / ALK 8800

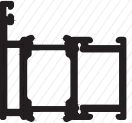
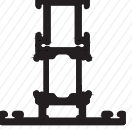
**ALK 6500T**  
ALK 6500T

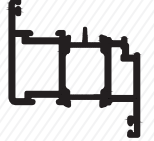
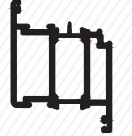

**İçindekiler / Contents**

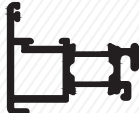
Profil Profile	Profil Kodu Profile No	Ağırlık (kg/m.) Weight (kg/m.)	X mm.	Y mm.	Jx cm <sup>4</sup>	Jy cm <sup>4</sup>
	3928-3930 Kasa Profili Frame Profile	1,424kg/m	65 mm	46 mm	10,5	37,01
	3870-3871 Kasa Profili Frame Profile	1,710kg/m	65 mm	61 mm	15,05	32,23
	3928-3929 Orta Kayıt Profili Mullion Profile	1,554kg/m	65 mm	65 mm	39,10	17,32
	3871-3872 Geniş Orta Kayıt Pr. Mullion Profile	1,840kg/m	65 mm	80 mm	23,40	12,10
	3864-3865 Duble Orta Kayıt Pr. Mullion Profile	2,974kg/m	65 mm	135 mm	43,66	79,06
	3931-3932 Kanat Profili Sash Profile	1,596kg/m	75 mm	46 mm	6,41	26,99
	3866-3867 Kanat Profili Sash Profile	1,907kg/m	75 mm	80 mm	15,00	33,65
	3855-3856 Kanat Profili Sash Profile	2,316kg/m	75 mm	100 mm	32,90	44,64
	3862-3863 Dışa Açılım KapıKanat Profili Door Sash Profile	2,389kg/m	75 mm	100 mm	31,00	45,01
	3874-3876 Adaptör Profili Adapter Profile	1,502kg/m	65mm	58 mm	9,28	21,62
	3935-3936 Pivot Adaptör Profili Adapter Profile	1,466kg/m	58 mm	69 mm	22,09	6,72



Profiller / Profiles

Kasa Profili - Frame Profile

3928-3930  
1,424 kg/mt

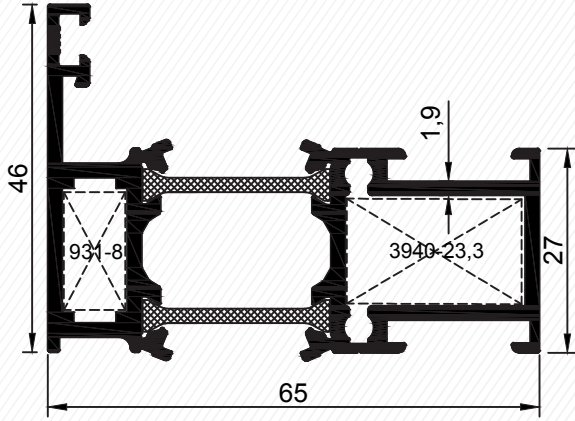

3928-3930

Geniş Kasa Profili - Frame Profile

3870-3871  
1,710 kg/mt

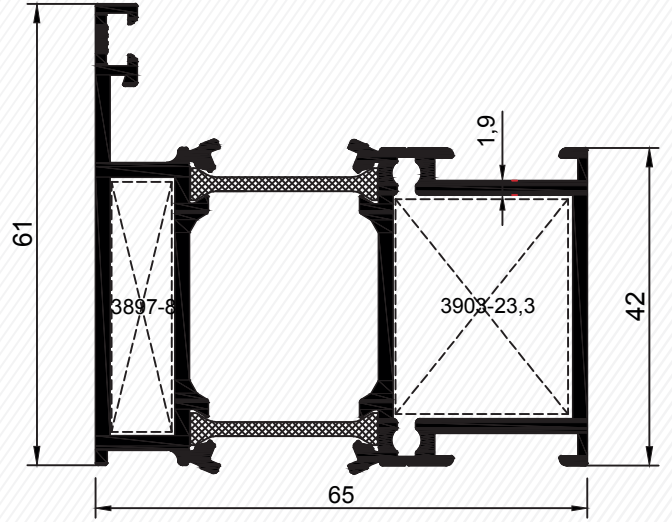

3870-3871

Kod	Et Kalın.	Ürün Adı	Ağırlığı	Köşe Takozu
3930-3928	1,9 mm	Kasa Profili	1,424 kg/mt	931-8 mm 3940-23,3 mm
3870-3871	1,9 mm	Kasa Profili	1,710 kg/mt	3897-8 mm 3903-23,3 mm

Orta Kayıt Profili - Mullion Profile

3929-3928

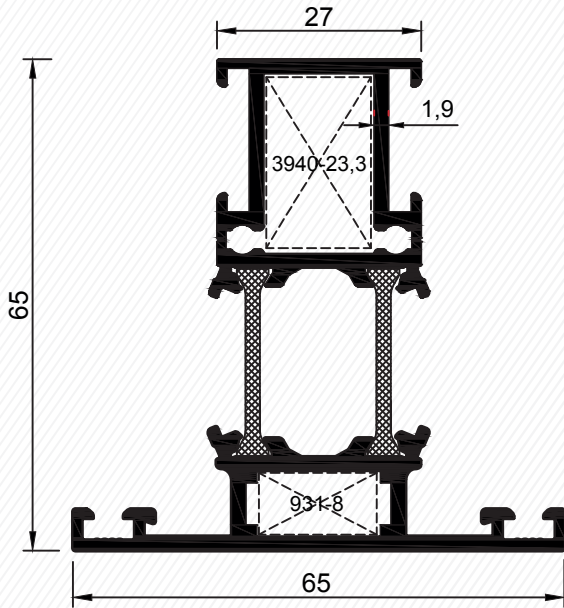

3929-3928

Geniş Orta Kayıt Profili - Mullion Profile

3872-3871  
1,840 kg/mt

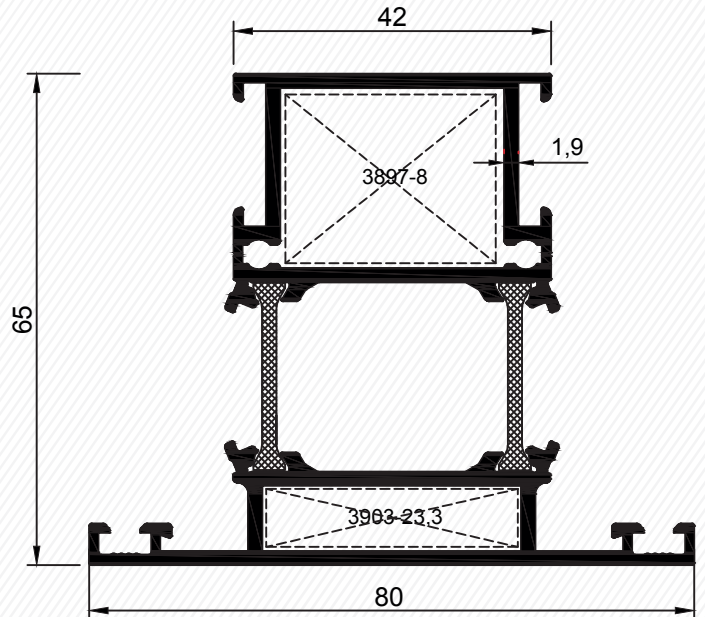

3872-3871

Kod	Et Kalın.	Ürün Adı	Ağırlığı	Köşe Takozu
3929-3928	1,9 mm	"T" Profili	1,554 kg/mt	931-8 mm 3940-23,3 mm
3872-3871	1,9 mm	"T" Profili	1,840 kg/mt	3897-8 mm 3903-23,3 mm

## Profiller / Profiles

Duble Orta Kayıt Profili - Double Mullion Profile

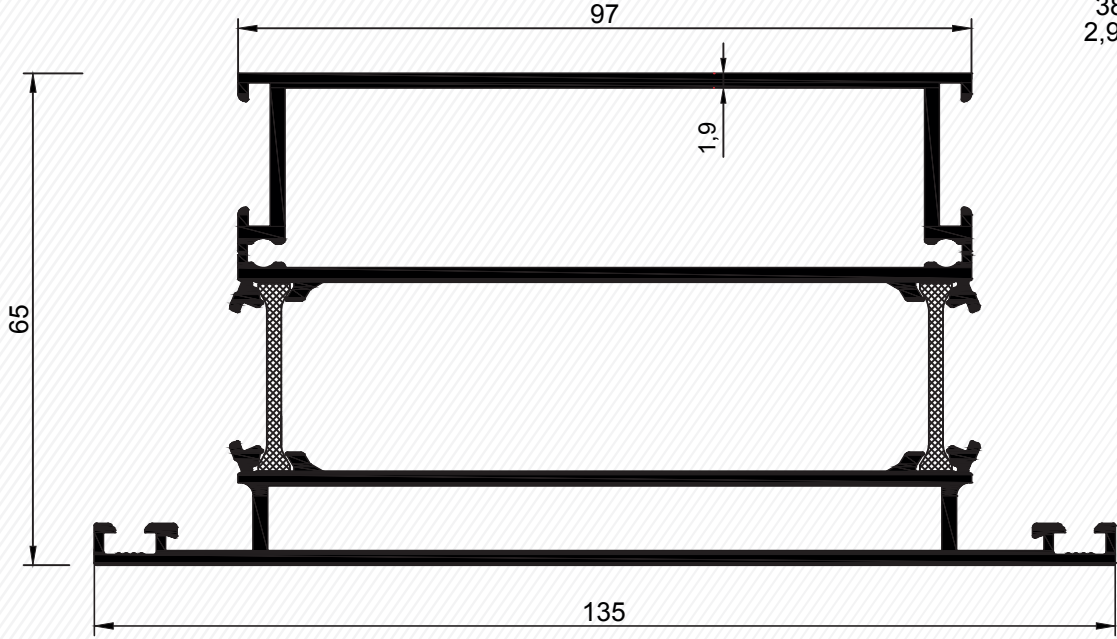
3864-3865  
2,974 kg/mt

3864-3865

Kod	Et Kalın.	Ürün Adı	Ağırlığı	Köşe Takozu
3864-3865	1,9 mm	"T" Profili	2,974 kg/mt	

Kanat Profili - Sash Profile

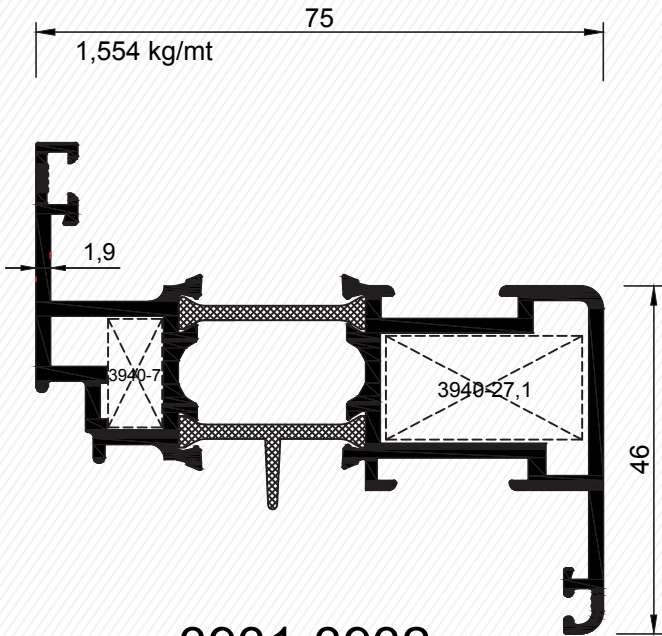
3931-3932  
1,596 kg/mt

3931-3932

Geniş Kanat Profili - Large Sash Profile

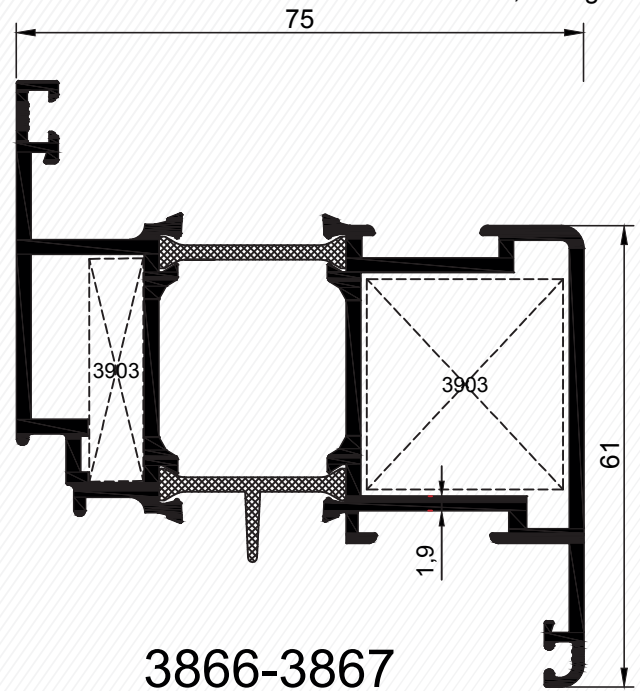
3866-3867  
1,907 kg/mt

3866-3867

Kod	Et Kalın.	Ürün Adı	Ağırlığı	Köşe Takozu
3931-3932	1,9 mm	Kanat Profili	1,596 kg/mt	3940-7 mm 3940-27,1 mm
3866-3867	1,9 mm	Kanat Profili	1,907 kg/mt	3903-7 mm 3903-27,1 mm

Profiller / Profiles

Kapı Kanat Profili - Door Sash Profile

3855-3856  
2,316 kg/mt

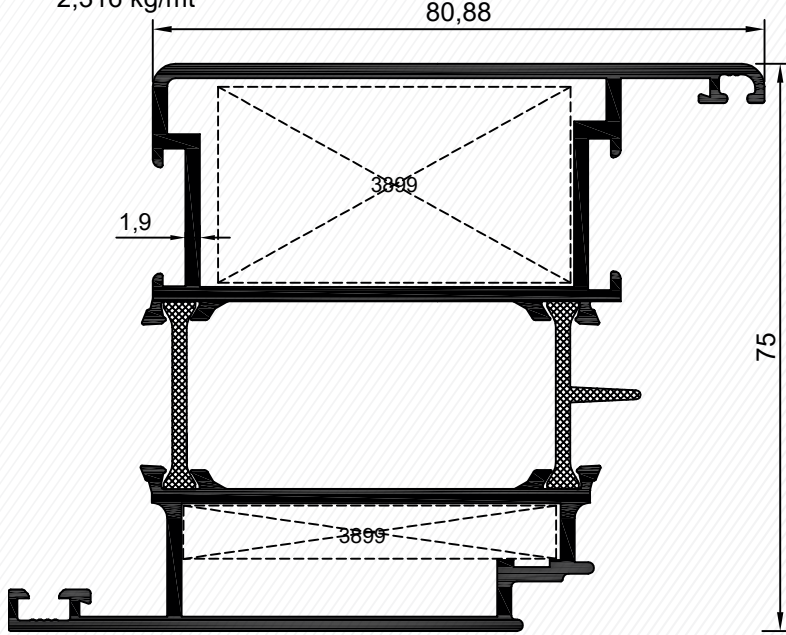

3855-3856

Çift Kanat Adaptör Profili - Adapter Profile

3874-3876  
1,465 kg/mt

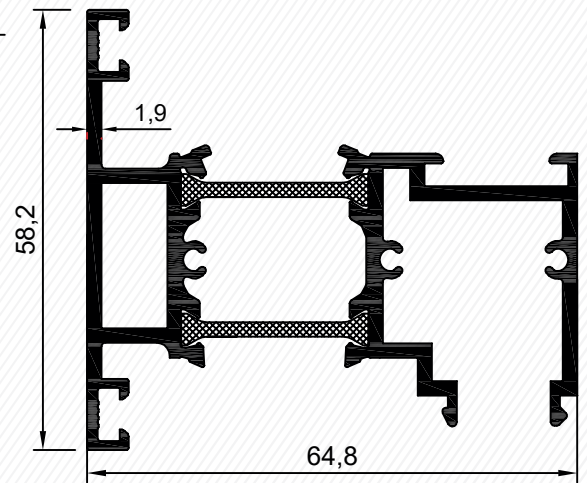

3874-3876

Kod	Et Kalın.	Ürün Adı	Ağırlığı	Köşe Takozu
3855-3856	1,9 mm	Kanat Profili	2,316 kg/mt	3899-7 mm 3899-27,1 mm
3874-3876	1,9 mm	Adaptör Profili	1,465 kg/mt	

Dışa Açılım Kapı Kanat - Door Sash Profile

3862-3863  
2,389 kg/mt

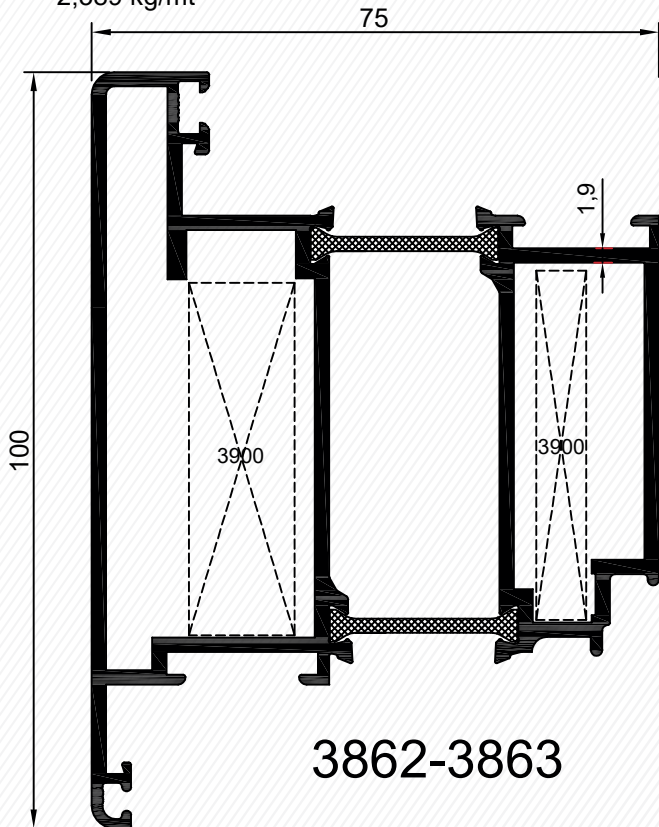

3862-3863

Dışa Açılım Adaptör Profili - Adapter Profile

3873-3875  
1,201 kg/mt

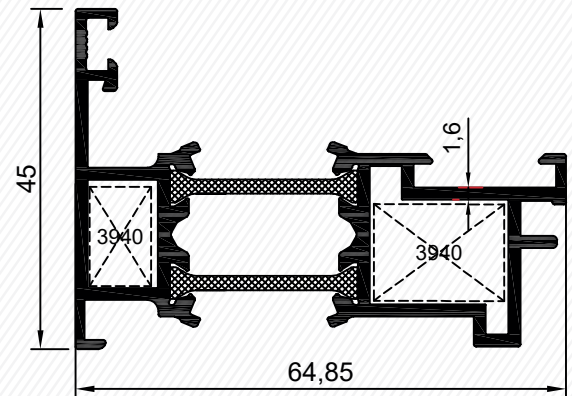

3873-3875

Kod	Et Kalın.	Ürün Adı	Ağırlığı	Köşe Takozu
3862-3863	1,9 mm	Kanat Profili	2,389 kg/mt	3900-27,1 mm 3900-7,3 mm
3873-3875	1,9 mm	Adaptör Profili	1,201 kg/mt	3940-8,7 mm 3940-17,7 mm

**Profiller / Profiles**

Pivot Adaptör Profili - Adapter Profile  
 3935-3936  
 1,466 kg/mt

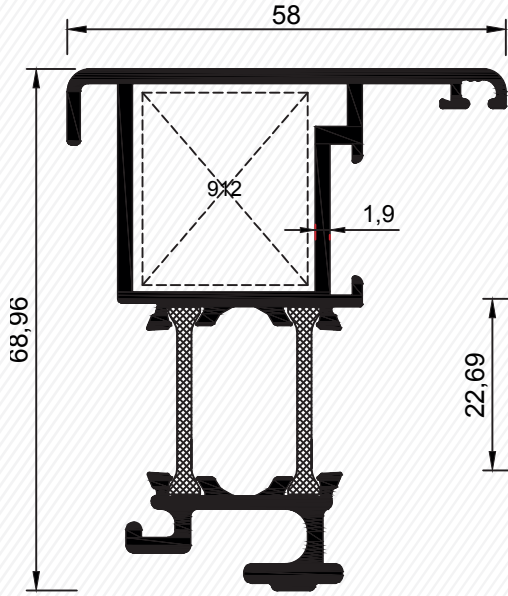

**3935-3936**

Tek Cam Çita Profili - Bead Glazing Profile

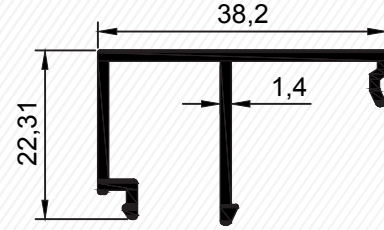

**3868**  
 0,348 kg/mt

Isı Cam Çita Profili - Bead Glazing Profile

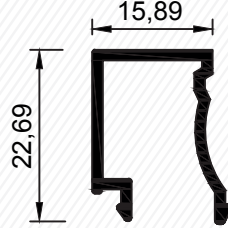

**5139**  
 0,245 kg/mt

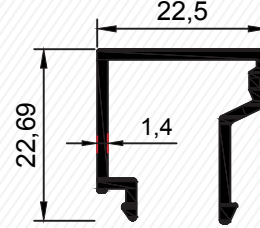

**3869**  
 0,281 kg/mt

Tij Profili - Rod Profile

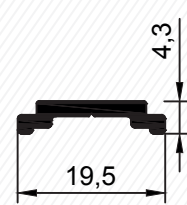

**1325**  
 0,125 kg/mt

Kod	Et Kalın.	Ürün Adı	Ağırlığı	Köşe Takozu
3935-3936	1,6 mm	Pivot Profili	1,466kg/mt	912-27,1 mm

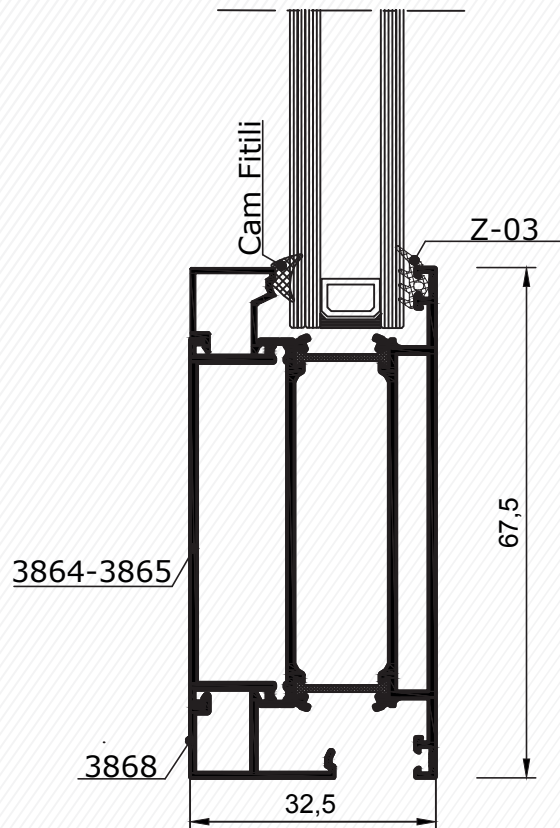
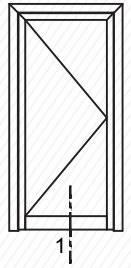
**Detaylar / Details**

1 DETAYI  
 DETAIL

Ölçek: 1:2 / Scale: 1:2



Detaylar / Details

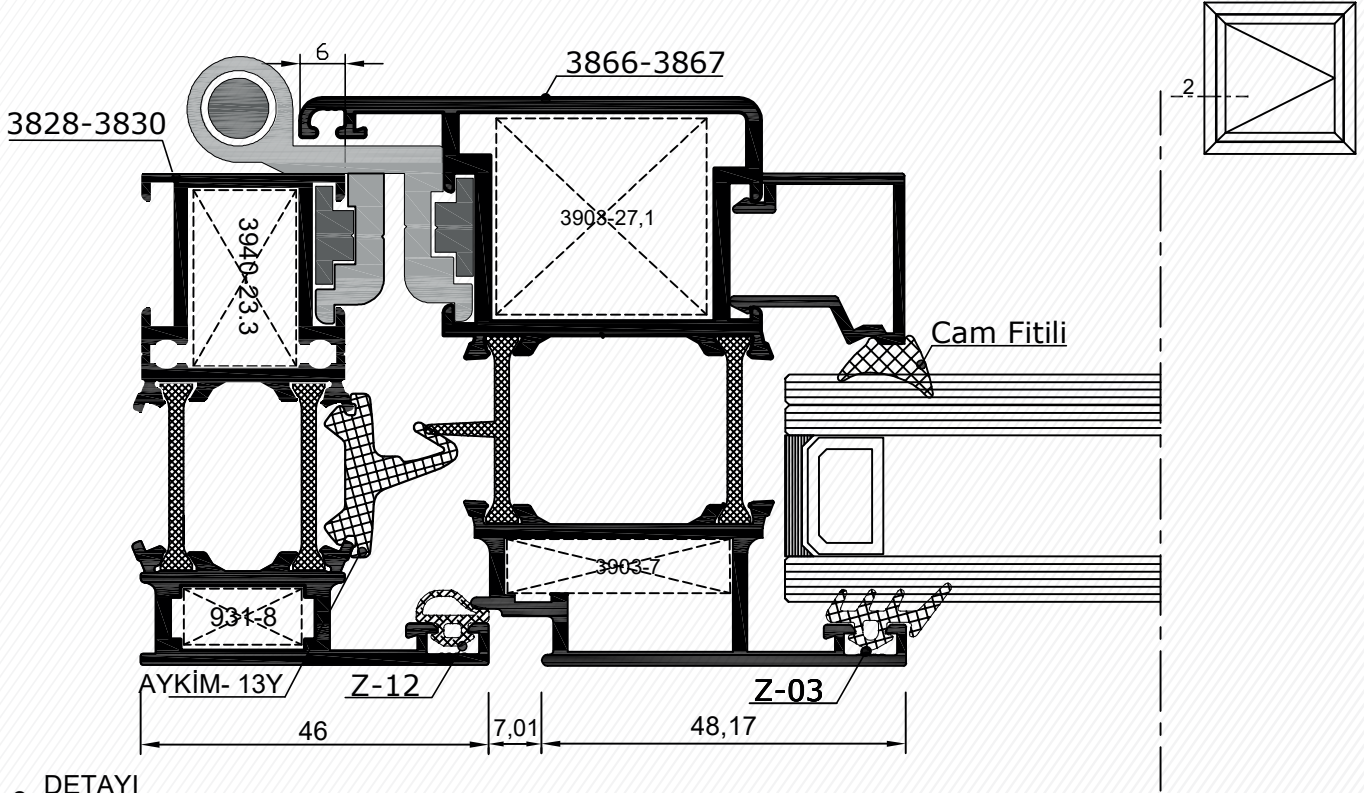

2 DETAYI  
DETAIL

Ölçek: 1:1 / Scale: 1:1

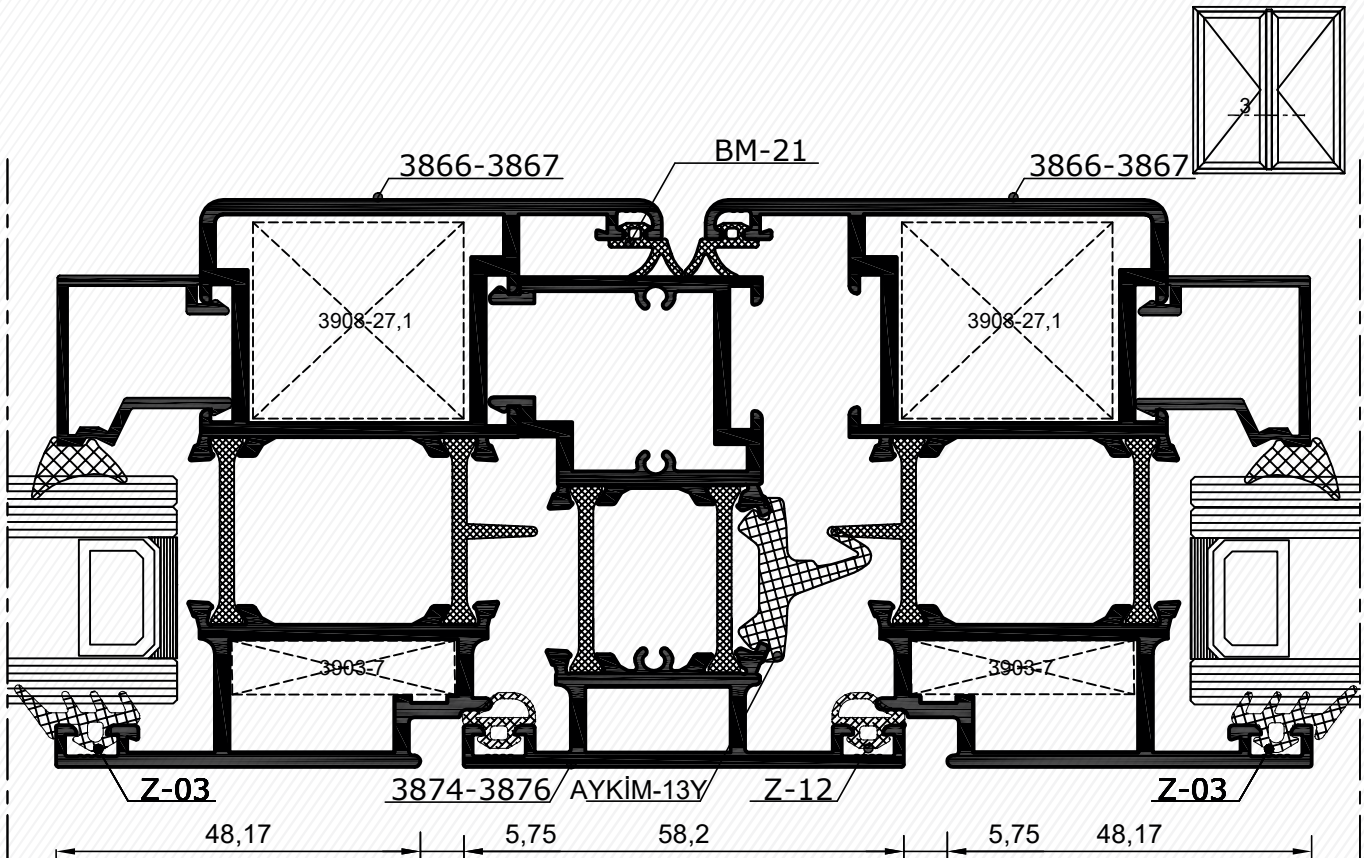

3 DETAYI  
DETAIL

Ölçek: 1:1 / Scale: 1:1

## Detaylar / Details

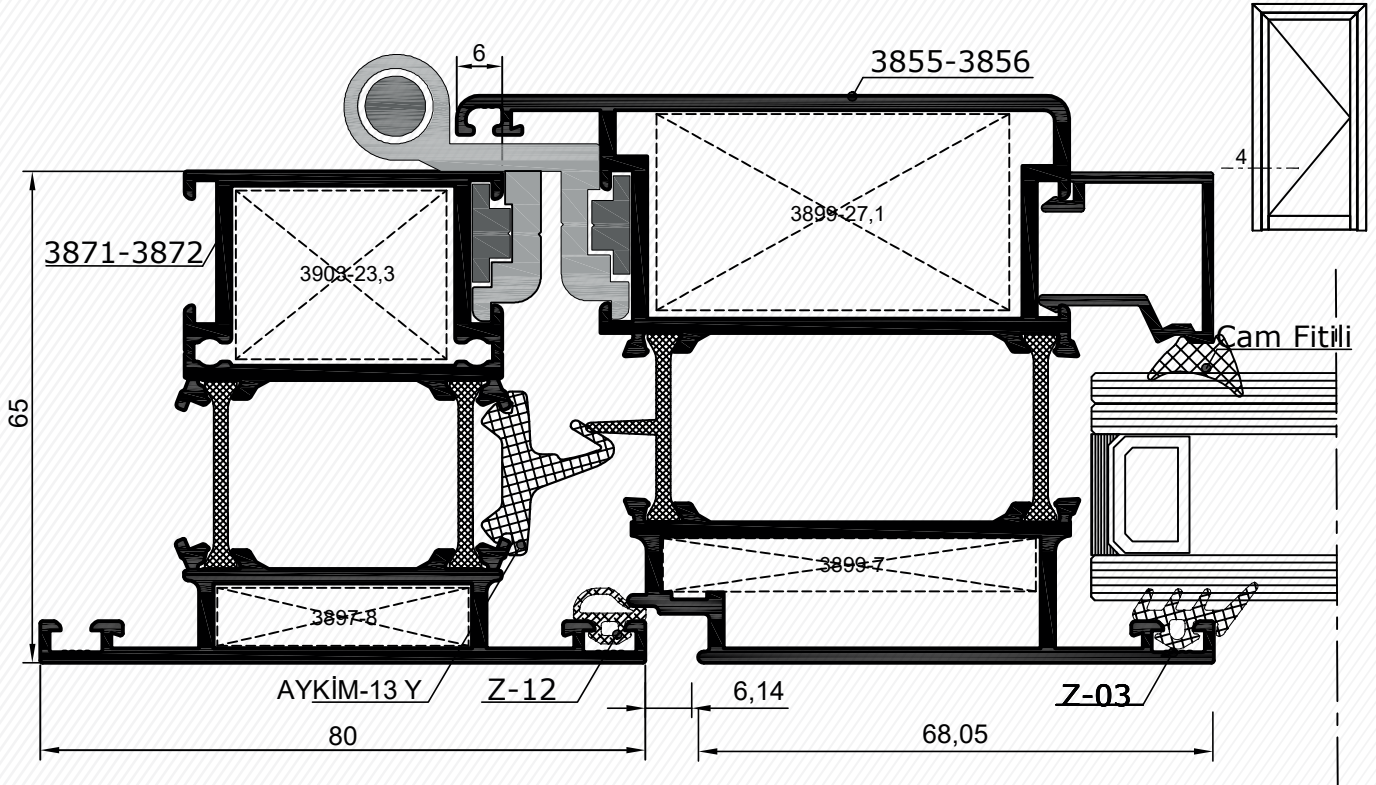
4 DETAYI  
DETAIL

Ölçek: 1:1 / Scale: 1:1

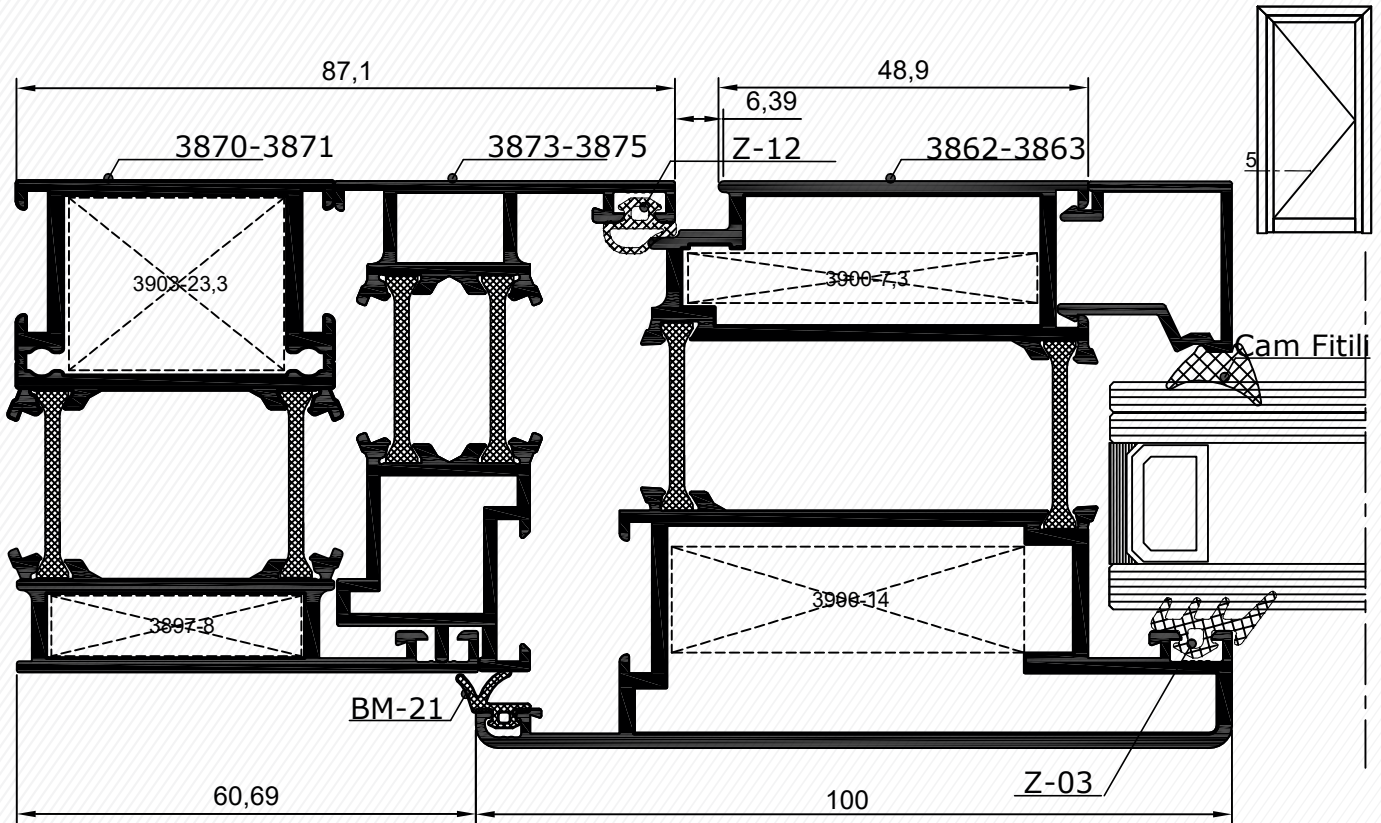
5 DETAYI  
DETAIL

Ölçek: 1:1 / Scale: 1:1

**Kesim Ölçüsü / Cut Size**

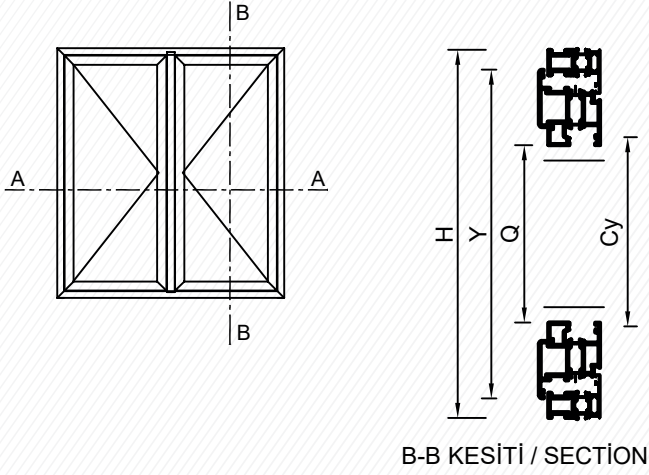

B-B KESİTİ / SECTION

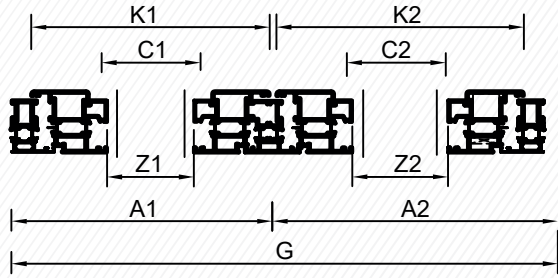

A-A KESİTİ / SECTION

HAREKETLİ ADAPTÖRLÜ PENCERE KESİM FORMÜLÜ

K1 = A1-24,06 mm	G = Kasa Genişliği / Frame Width
K2 = A2-24,15 mm	H = Kasa Yüksekliği / Frame Height
Y = H-42 mm	K = Kanat Genişliği / Sash Width
Z = A1-146 / A2-146	Y = Kanat Yüksekliği / Frame Height
Q = H-202 mm	Z = Çıta Genişliği / Glazing Bead Width
C1 = A1-157	Q = Çıta Yüksekliği / Glazing Bead Height
C2 = A2-157	C = Cam Genişliği / Glass Width
Cy = H-175 mm	Cy = Cam Yüksekliği / Glass Height

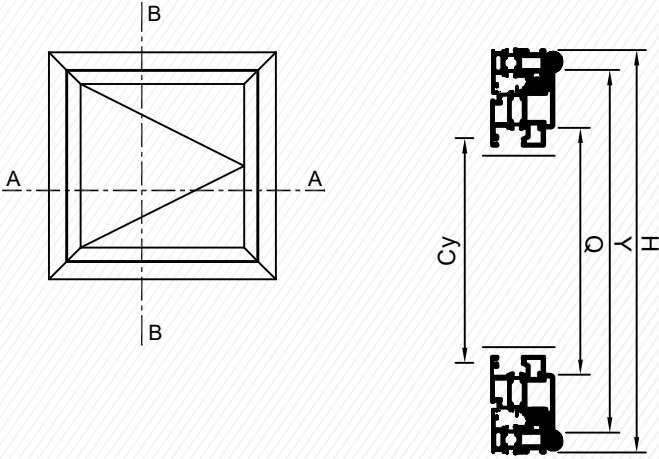

B-B KESİTİ / SECTION

PENCERE KESİM FORMÜLÜ



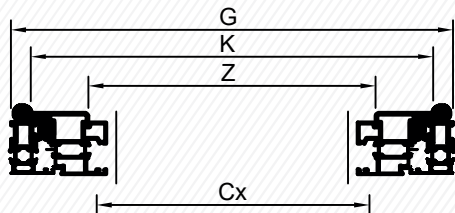







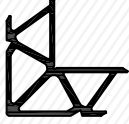

K = G - 42 mm	G = Kasa Genişliği / Frame Width
Y = H - 42 mm	H = Kasa Yüksekliği / Frame Height
Z = G - 165 mm	K = Kanat Genişliği / Sash Width
Q = H - 202 mm	Y = Kanat Yüksekliği / Frame Height
Cx = G - 175 mm	Z = Çıta Genişliği / Glazing Bead Width
Cy = H - 175 mm	Q = Çıta Yüksekliği / Glazing Bead Height
	Cx = Cam Genişliği / Glass Width
	Cy = Cam Yüksekliği / Glass Height













A-A KESİTİ / SECTION

Kesim ölçüsü - cam ölçüsü vb. sorumluluğu tarafımıza ait değildir.

### Aksesuarlar / Accessories

Ürün Çizimi Drawing	Ürün Kodu Product No	Ürün Adı Product Name	Kullanıldığı Profiller Profiles Used
	931- 8	Köşe Takoza 15,6 mm Joint Corner	3930-3929
	3940-23,3	Köşe Takoza 13,8 mm Joint Corner	3928
	3897- 8	Köşe Takoza 33,7 mm Joint Corner	3870-3872
	3903-23,3	Köşe Takoza 29 mm Joint Corner	3871
	3940- 7	Köşe Takoza 13,8 mm Joint Corner	3932
	3940-27,1	Köşe Takoza 13,8 mm Joint Corner	3931
	3903- 7	Köşe Takoza 29 mm Joint Corner	3866
	3903-27,1	Köşe Takoza 29 mm Joint Corner	3867
	3899- 7	Köşe Takoza 49 mm Joint Corner	3855
	3899- 27,1	Köşe Takoza 49 mm Joint Corner	3856
	3900- 27,1	Köşe Takoza 46,8 mm Joint Corner	3863
	3900- 7,3	Köşe Takoza 46,8 mm Joint Corner	3862

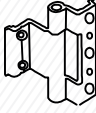
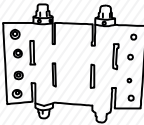
**Aksesuarlar / Accessories**

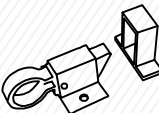
Ürün Çizimi Drawing	Ürün Kodu Product No	Ürün Adı Product Name	Kullanıldığı Profiller Profiles Used
	3940- 8,7	Köşe Takoğu 13,8 mm Joint Corner	3873
	3940- 17,7	Köşe Takoğu 13,8 mm Joint Corner	3875
	912-27,10	Köşe Takoğu 23,5 mm Joint Corner	3935
	Z-12	Kasa Bini Fitili 32 gr/mt Brush For Frame	-
	BM-21	Kasa Bini Fitili 28 gr/mt Brush For Sash	-
	AYKİM-13Y	Orta Tozluk Fitili 156 gr/mt Middle Brush	-
	Z-03	Cam Fitili 53 gr/mt Brush	-
	AYKİM-02 AYKİM-03 AYKİM-04	Cam Fitili 5 mm Cam Fitili 4 mm Cam Fitili 3 mm Brush For Glass	-
	153-01-320 153-01-321 153-01-322	Menteşe - Hinge 320-Gümüş, 321-Renkli, 322-Beyaz 320-Silver 321-Color 322-White	-
	153-02-034	Çarpma Mentefe Swing Door Hinge	-
	153-01-087 153-01-088 153-01-089	Vasistas Makas Transom Window 087-Gümüş, 088-Renkli, 089-Beyaz 087-Silver, 088-Color, 089-White	-
	153-01-101 153-01-102 153-01-103	Vasistas Çarpma Transom Window Lock 101-Gümüş, 102-Renkli, 103-Beyaz 101-Silver, 102-Color, 103-White	-

