

ALKOR

ALUMINUM



ENDÜSTRİYEL PROFİLLER

INDUSTRIAL PROFILES

- HALI VE SÜPÜRGELİK PROFİLLERİ / CARPET AND BASEBOARD PROFILES
- MOBİLYA PROFİLLERİ / FURNITURE PROFILES
- SERA PROFİLLERİ / GREENHOUSE PROFILES
- SANAYİ VE KAROSER PROFİLLERİ / INDUSTRIAL AND BODYWORK PROFILES
- ELEKTRONİK PROFİLLERİ / ELECTRONIC PROFILES
- DİLATASYON PROFİLLERİ / DILATATION PROFILES
- OTOMOTİV PROFİLLERİ / AUTOMOTIVE PROFILES
- REKLAM PROFİLLERİ / ADVERTISING PROFILES
- KLİMA & MENFEZ PROFİLLERİ / AIR CONDITION & VENT PROFILES
- ÖZEL AMAÇLI PROFİLLERİ / SPECIAL PURPOSE PROFILES
- SERAMİK CEPHE SİSTEM PROFİLLERİ / CERAMIC FACADE SYSTEM PROFILES
- SİNERFLEX PROFİLLERİ / SİNERFLEX PROFILES

MOBİLYA PROFİLLERİ

FURNITURE PROFILES



Profiller / Profiles

492

0,297 kg/mt

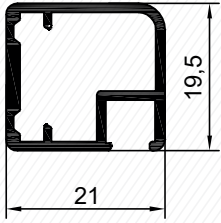

950

0,501 kg/mt

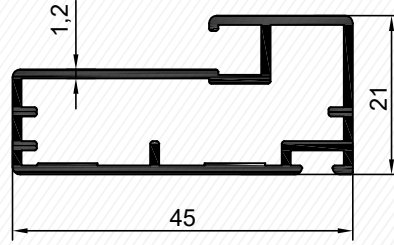

1239

0,318 kg/mt

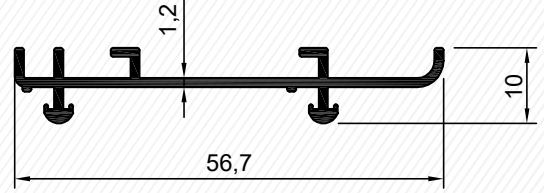

1240

0,556 kg/mt

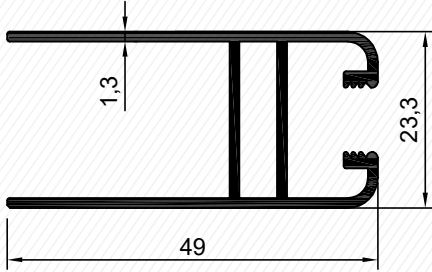

1241

0,374 kg/mt

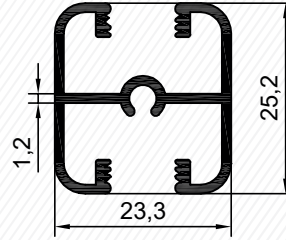

1242

0,539 kg/mt

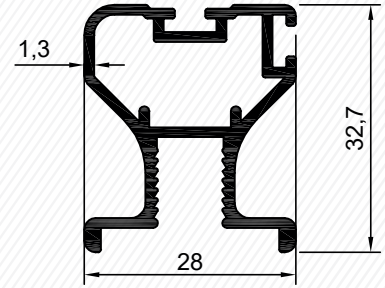

1243

0,321 kg/mt

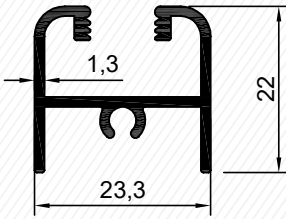

1244

0,751 kg/mt

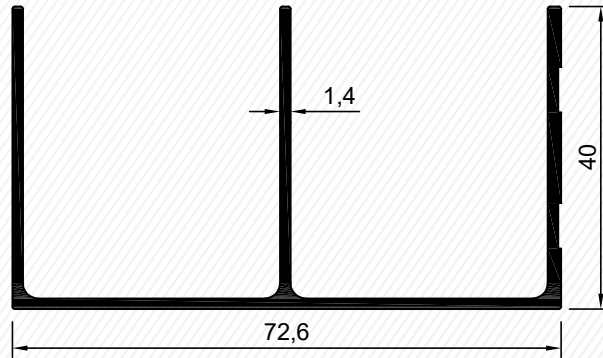

1271

0,545 kg/mt

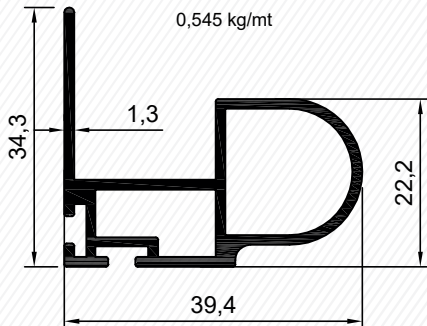

1272

0,523 kg/mt

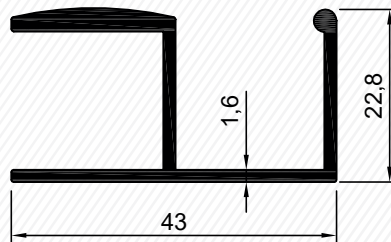

1273

0,331 kg/mt

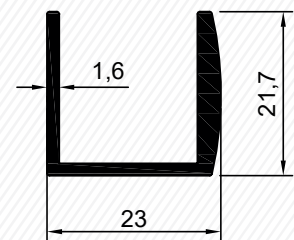

Profiller / Profiles

1284

0,512 kg/mt

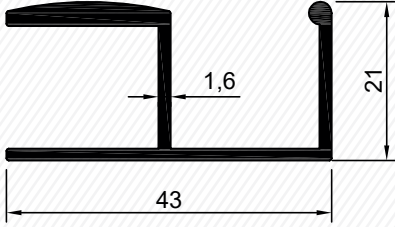

1294

0,563 kg/mt

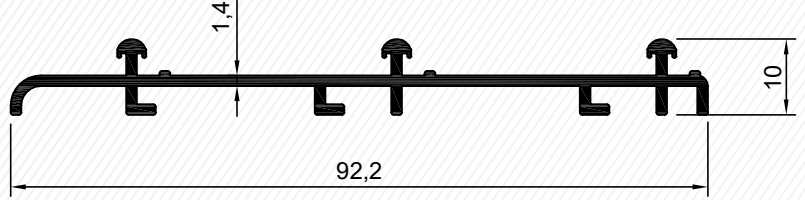

1429

0,321 kg/mt

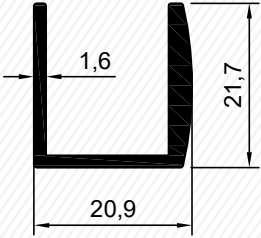

1295

0,909 kg/mt

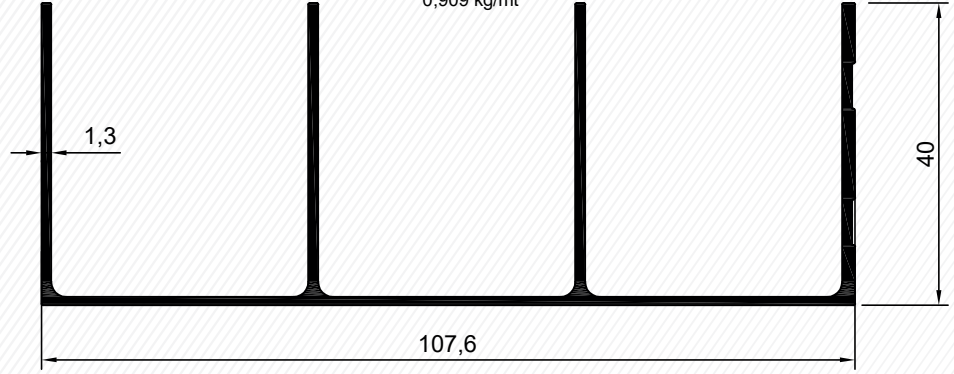

1522

0,230 kg/mt

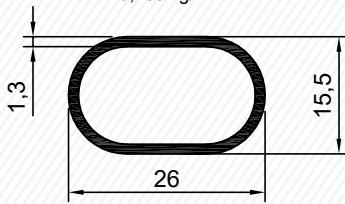

1608

0,099 kg/mt

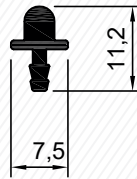

1609

0,309 kg/mt

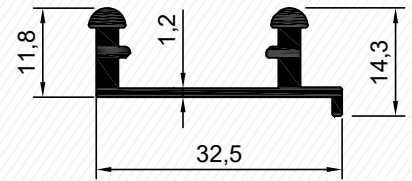

1611

0,327 kg/mt

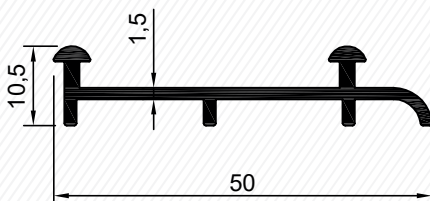

1612

0,586 kg/mt

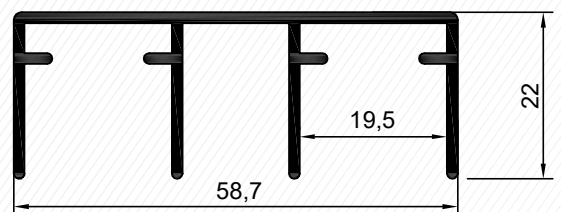

Profiller / Profiles

1613

0,488 kg/mt

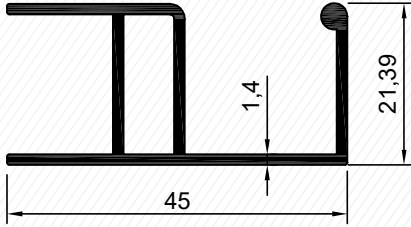

1614

0,305 kg/mt

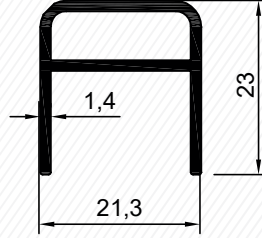

1615

0,353 kg/mt

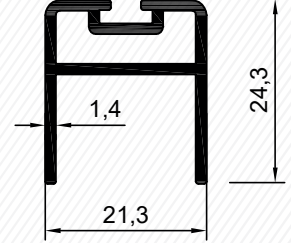

1616

0,458 kg/mt

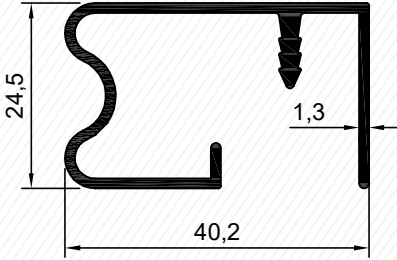

1617

0,442 kg/mt

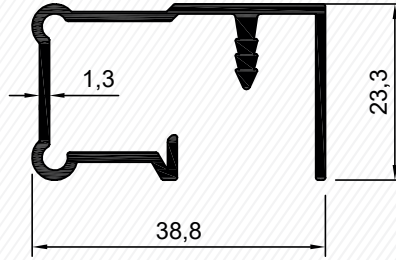

1618

0,523 kg/mt

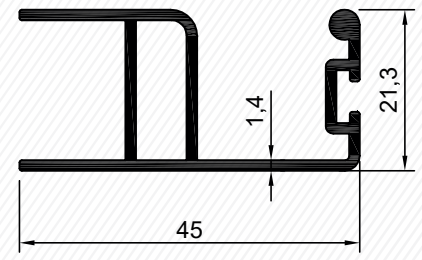

1619

0,380 kg/mt

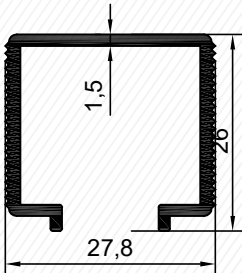

1620

0,171 kg/mt

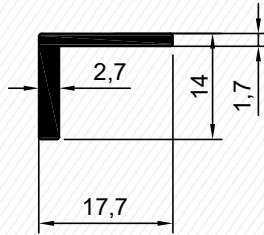

1610

0,428 kg/mt

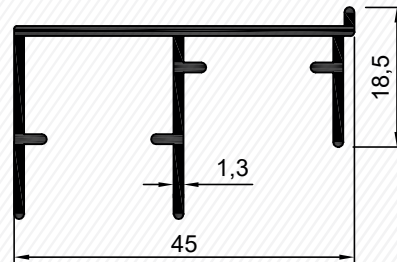

1679

0,125 kg/mt

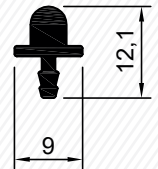

1741

0,568 kg/mt

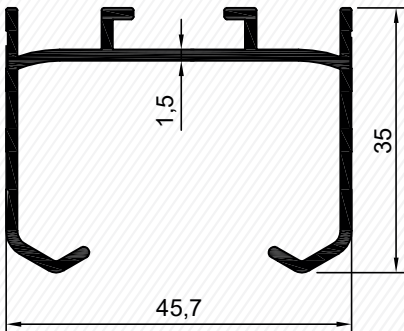

1749

0,445 kg/mt

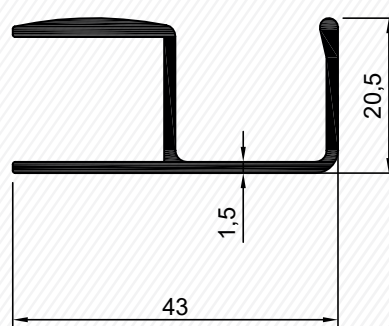

1750

0,422 kg/mt

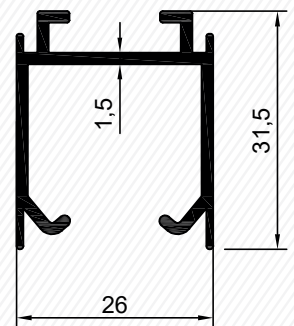

Profiller / Profiles

1751

0,463 kg/mt

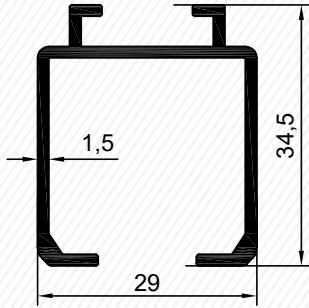

1752

0,485 kg/mt

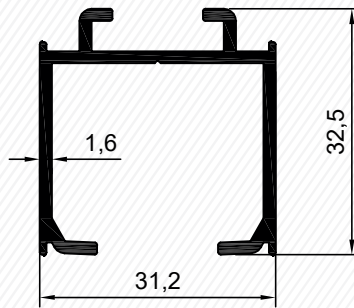

1827

0,230 kg/mt

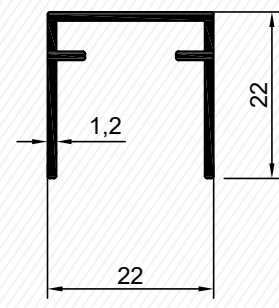

1924

0,272 kg/mt

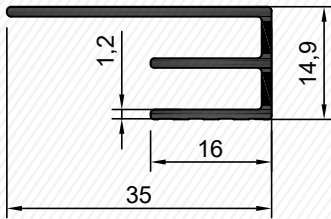

1925

0,119 kg/mt

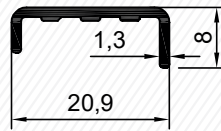

1926

0,529 kg/mt

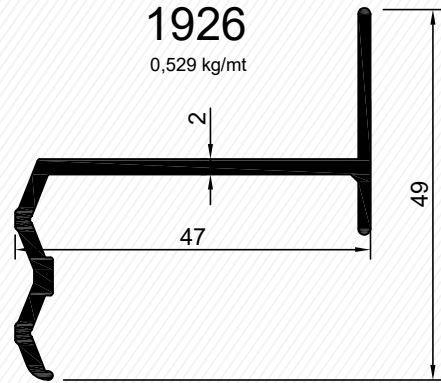

1927

0,431 kg/mt

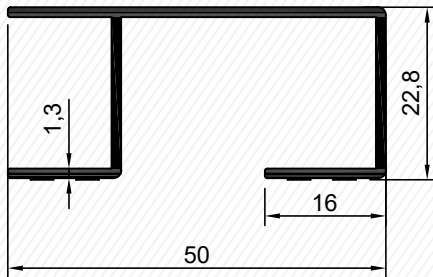

1928

0,634 kg/mt

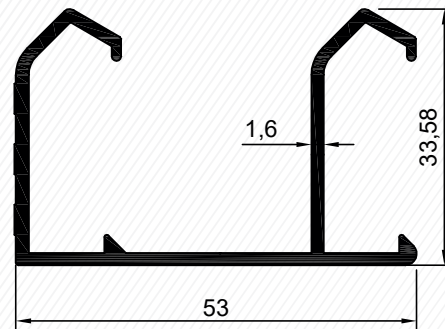

1957

0,422 kg/mt

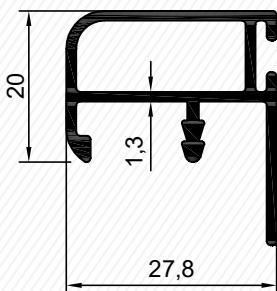

1958

0,460 kg/mt

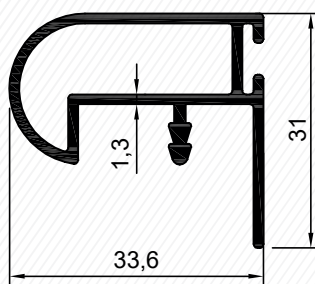

1961

0,101 kg/mt

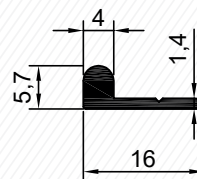

1962

0,123 kg/mt

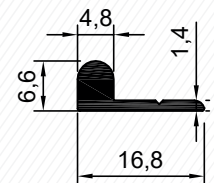

Profiller / Profiles

1974

0,530 kg/mt

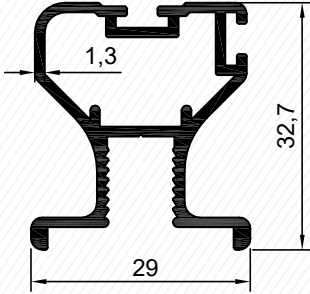

1981

0,572 kg/mt

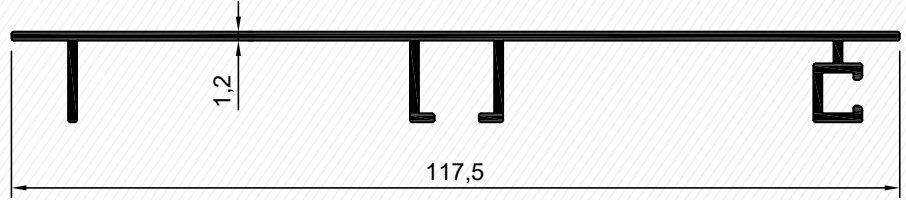

1987

0,442 kg/mt

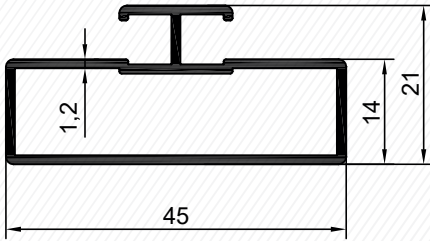

1988

0,283 kg/mt

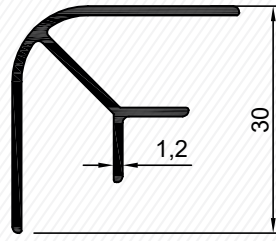

2005

0,466 kg/mt

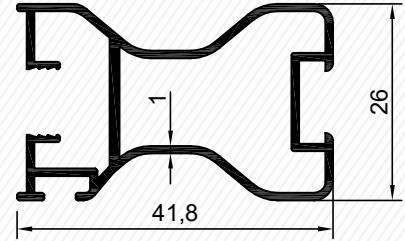

2006

0,242 kg/mt

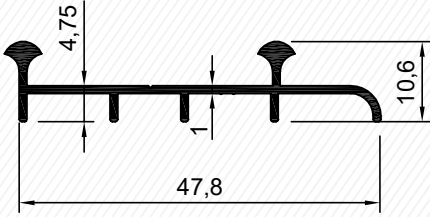

2007

0,410 kg/mt

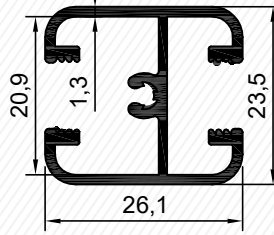

2008

0,557 kg/mt

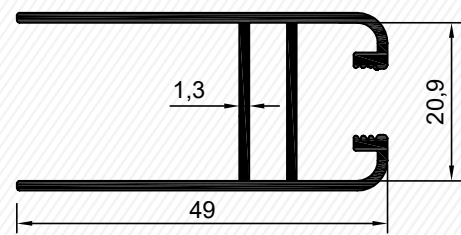

2009

0,239 kg/mt

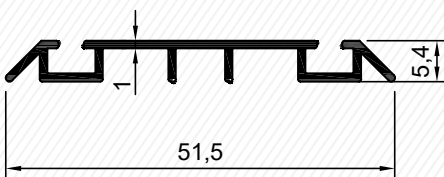

2010

0,510 kg/mt

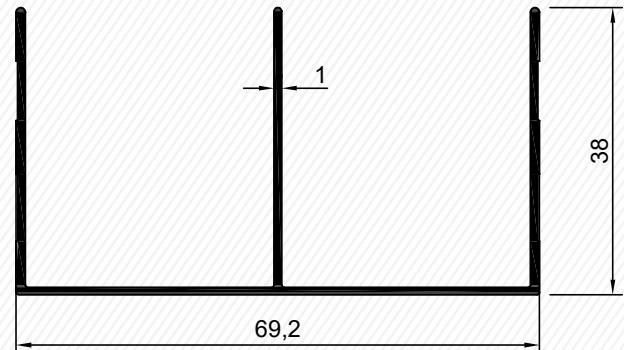

Profiller / Profiles

2011

0,314 kg/mt

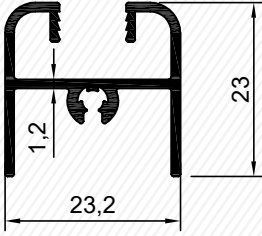

2104

0,450 kg/mt

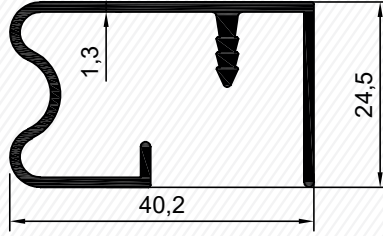

2171

0,530 kg/mt

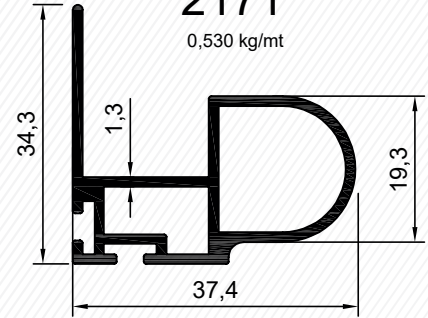

2174

0,444 kg/mt

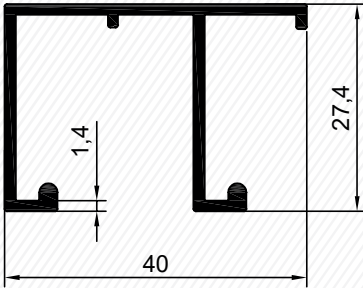

2251

0,217 kg/mt

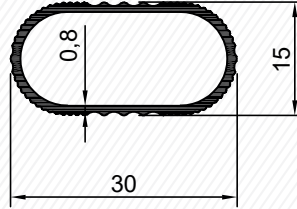

2266

0,481 kg/mt

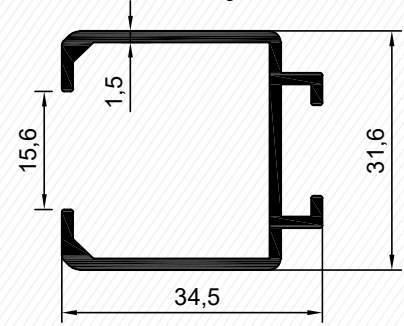

2267

0,567 kg/mt

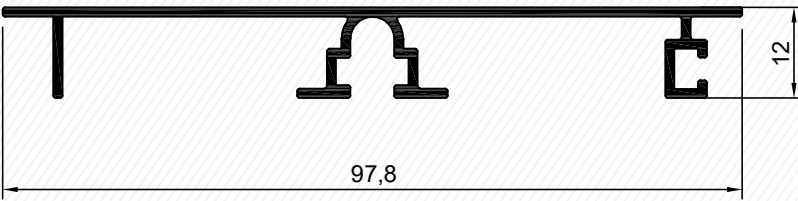

2285

0,459 kg/mt

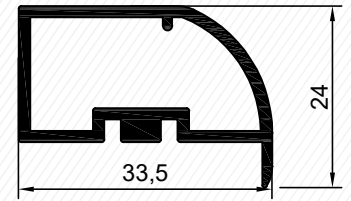

2365

0,642 kg/mt

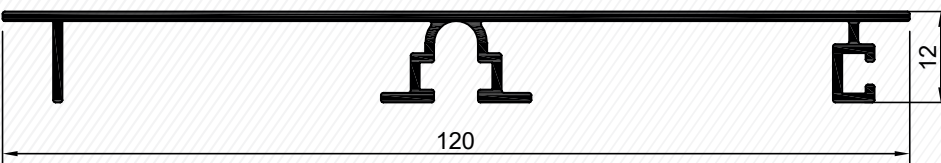

2367

0,399 kg/mt

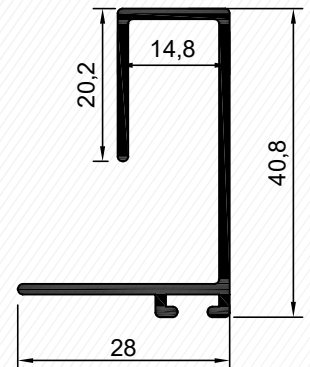

Profiller / Profiles

2366

0,598 kg/mt

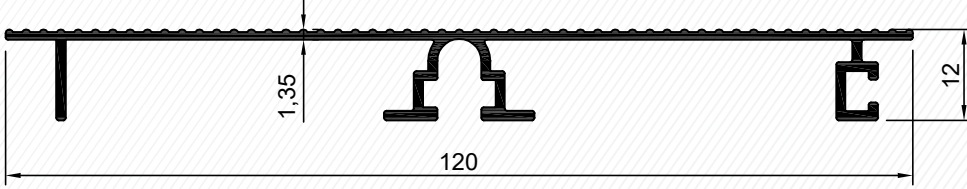

2402

0,200 kg/mt

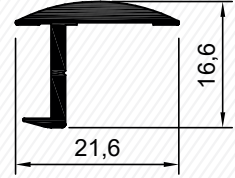

2403

1,813 kg/mt

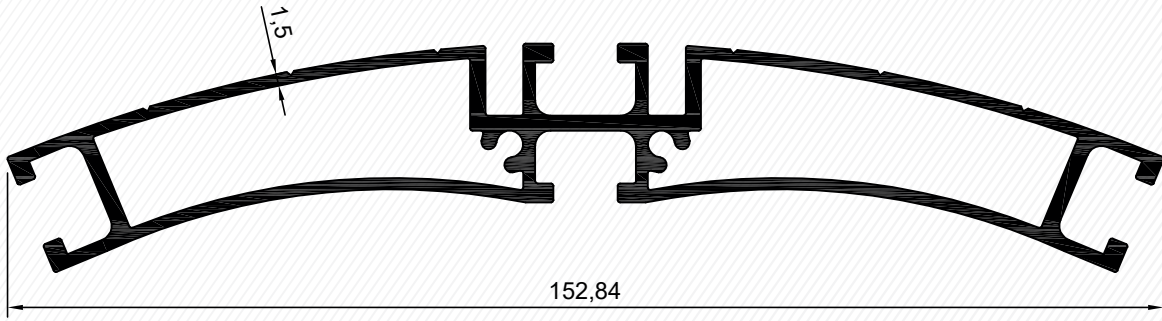

2435

0,456 kg/mt

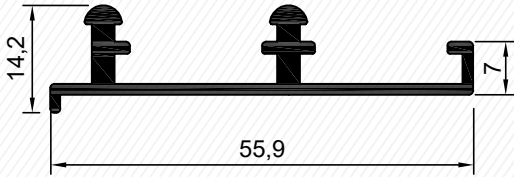

2436

0,275 kg/mt

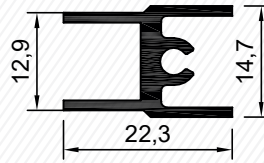

2437

0,341 kg/mt

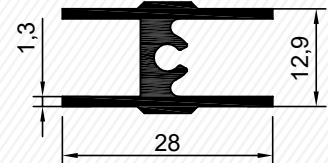

2438

0,497 kg/mt

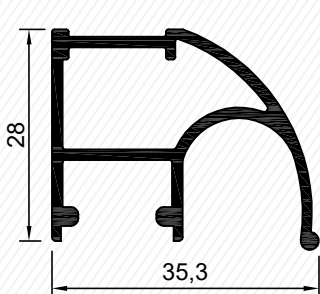

2439

0,540 kg/mt

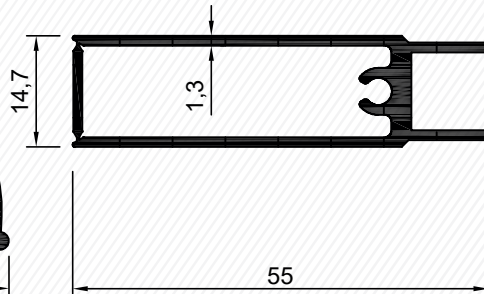

2440

0,344 kg/mt

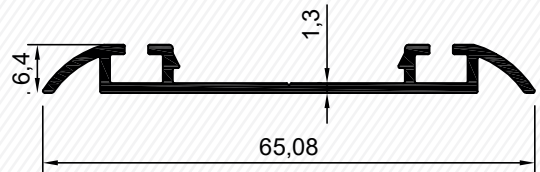

Profiller / Profiles

2441

0,697 kg/mt

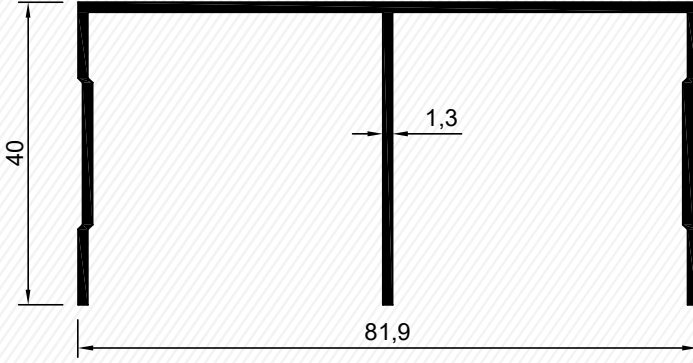

2478

0,722 kg/mt

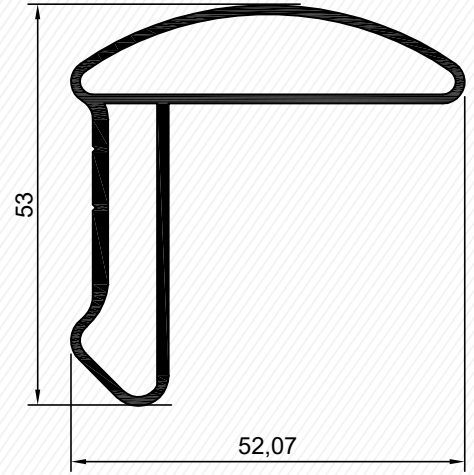

2442

0,134 kg/mt

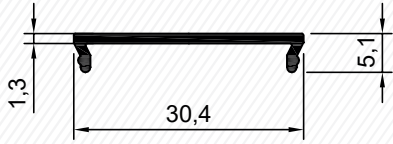

2502

0,424 kg/mt

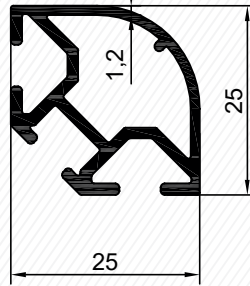

2503

0,438 kg/mt

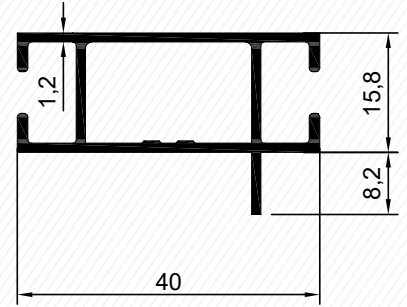

2504

0,284 kg/mt

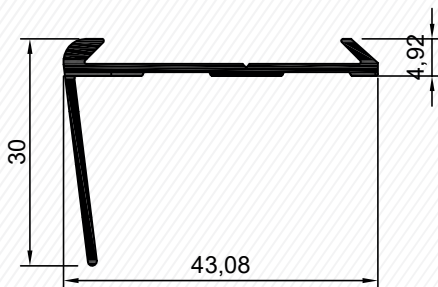

2539

0,271 kg/mt

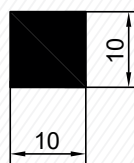

2541

0,237 kg/mt

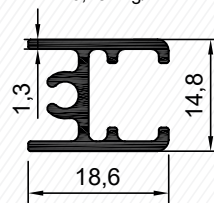

2542

0,321 kg/mt

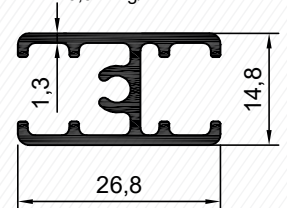

Profiller / Profiles

2543

0,486 kg/mt

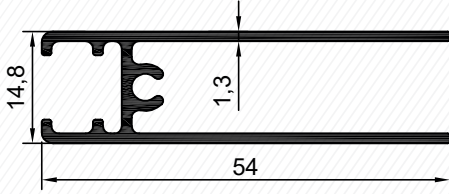

2544

0,267 kg/mt

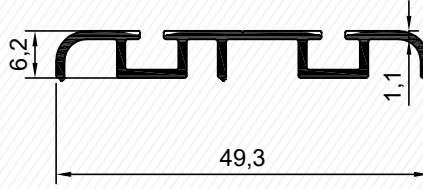

2545

0,484 kg/mt

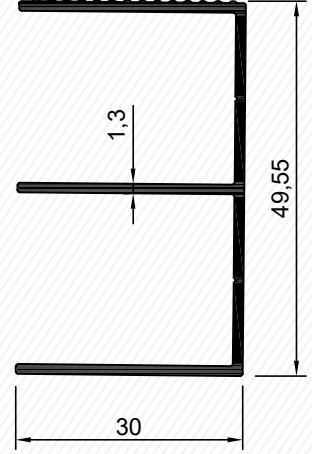

2546

0,462 kg/mt

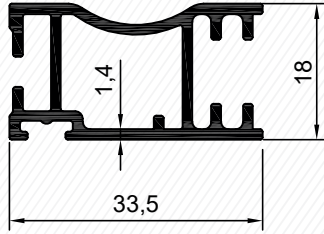

2548

0,170 kg/mt

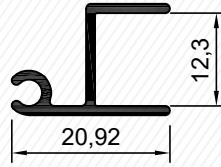

2565

0,548 kg/mt

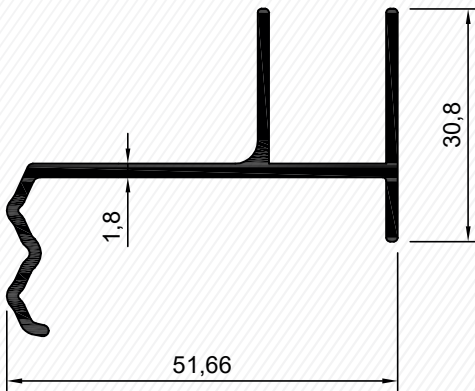

2573

0,272 kg/mt

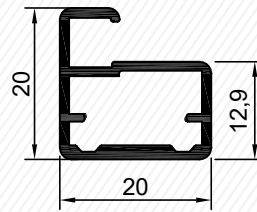

2595

0,467 kg/mt

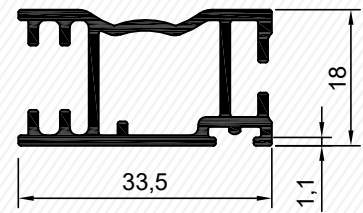

2675

0,083 kg/mt

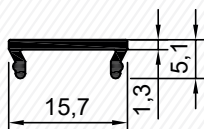

2654

0,222 kg/mt

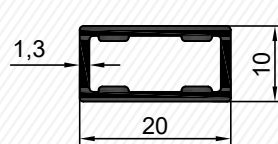

2655

0,203 kg/mt

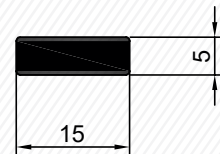

Profiller / Profiles

2667

1,569 kg/mt

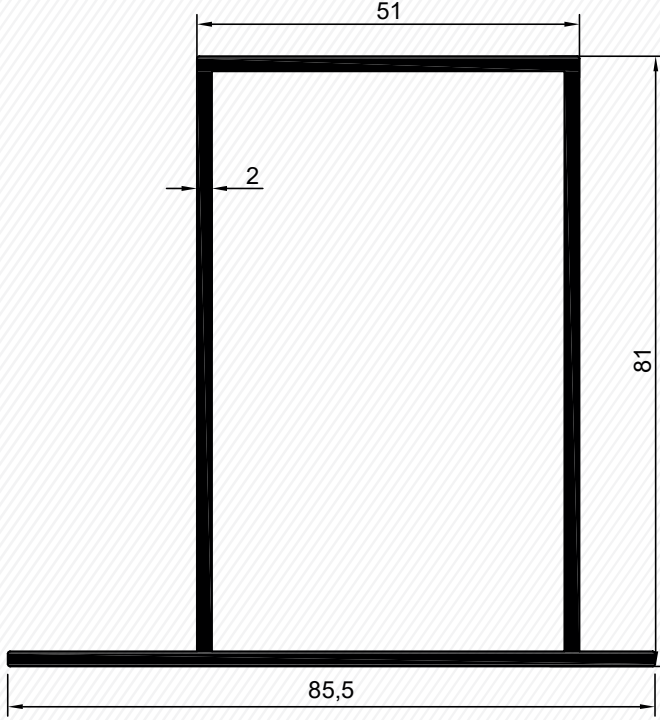

2674

0,404 kg/mt

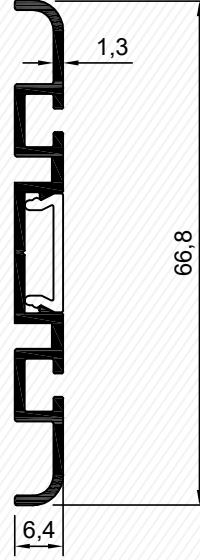

2659

0,601 kg/mt

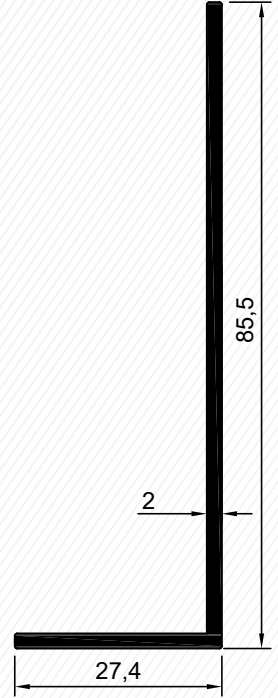

2832

0,677 kg/mt

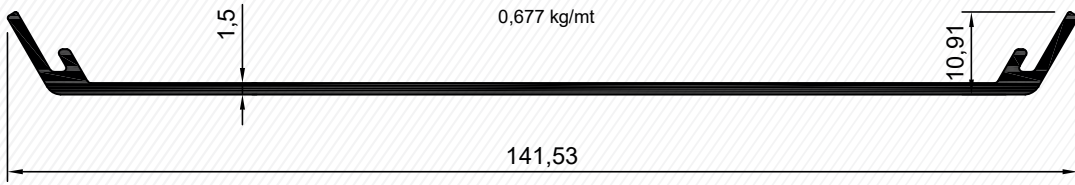

2833

0,782 kg/mt

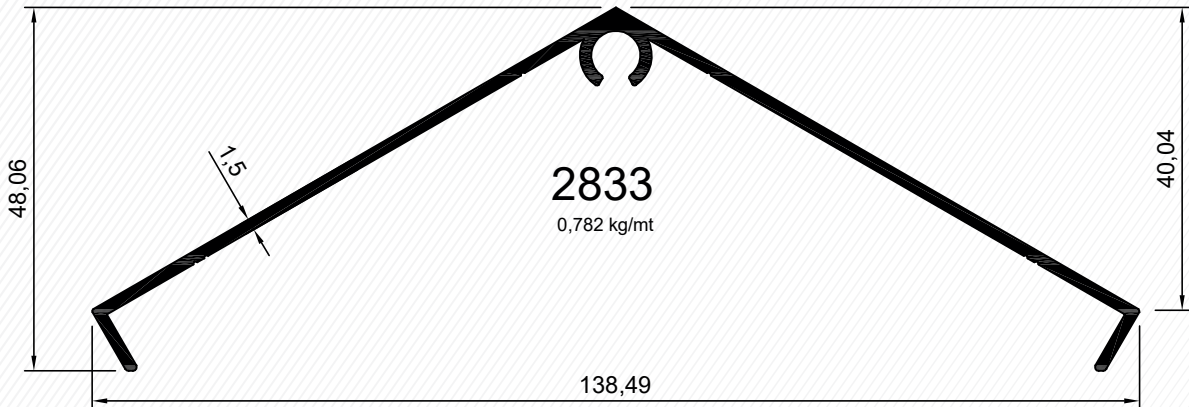

Profiller / Profiles

2834

0,539 kg/mt

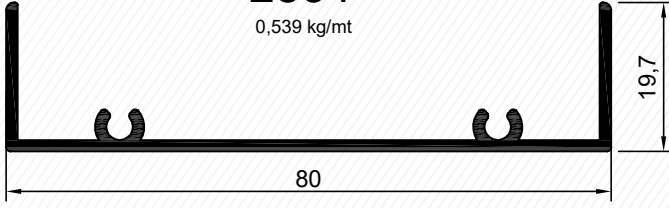

2835

0,195 kg/mt

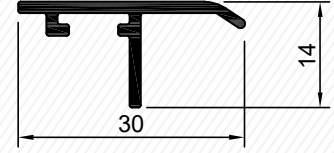

2836

0,183 kg/mt

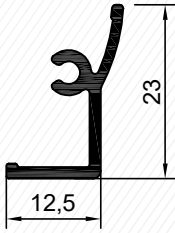

3537

0,705 kg/mt

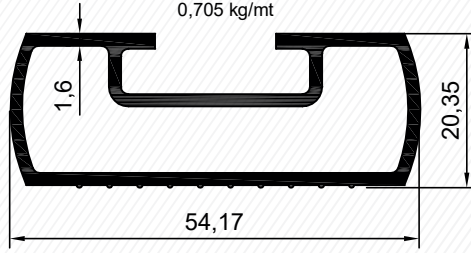

3545

0,247 kg/mt

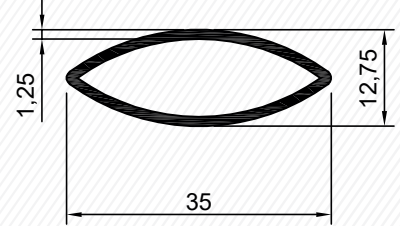

2549

2,794 kg/mt

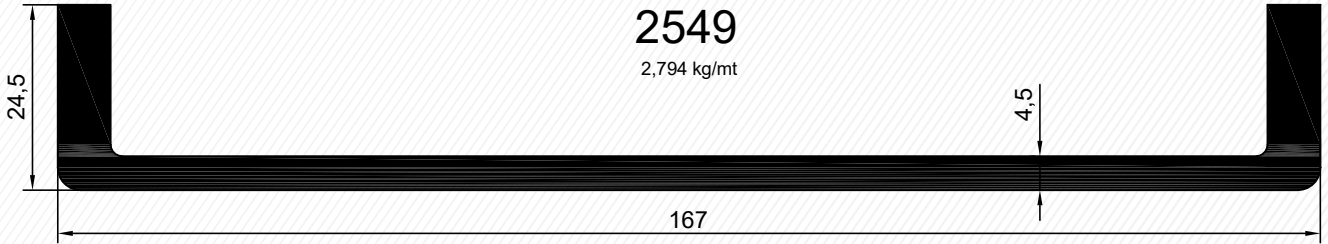

3617

0,245 kg/mt

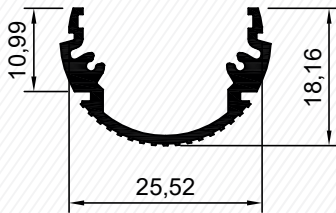

2656

0,307 kg/mt

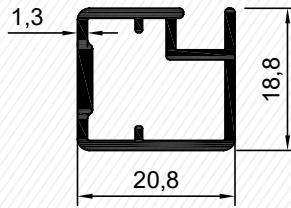

3642

0,221 kg/mt

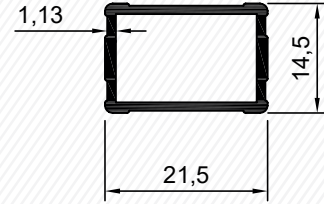

3762

0,207 kg/mt

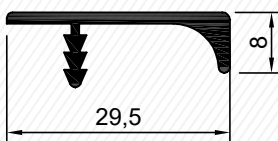

3809

0,102 kg/mt



3544

0,665 kg/mt

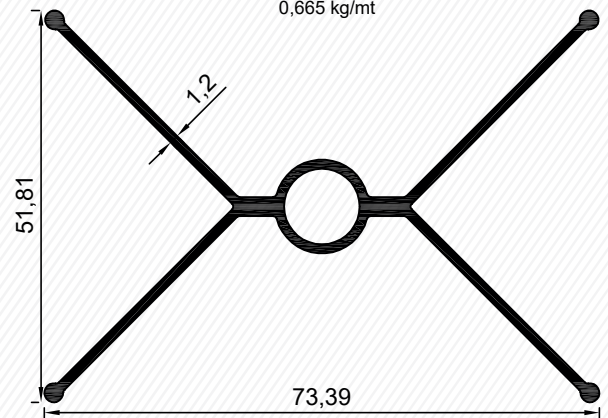

Profiller / Profiles

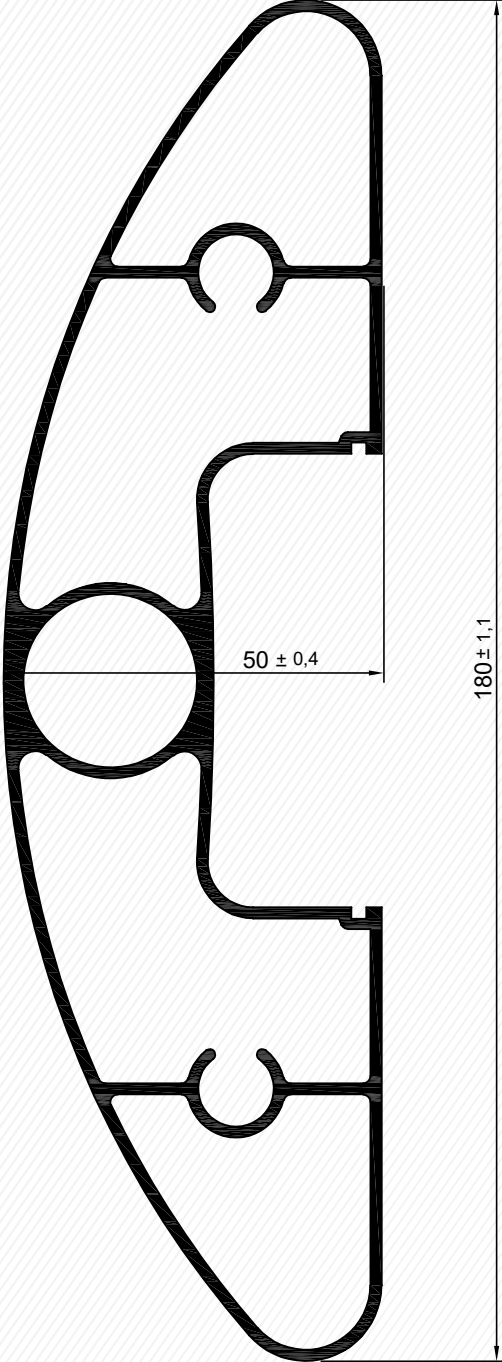
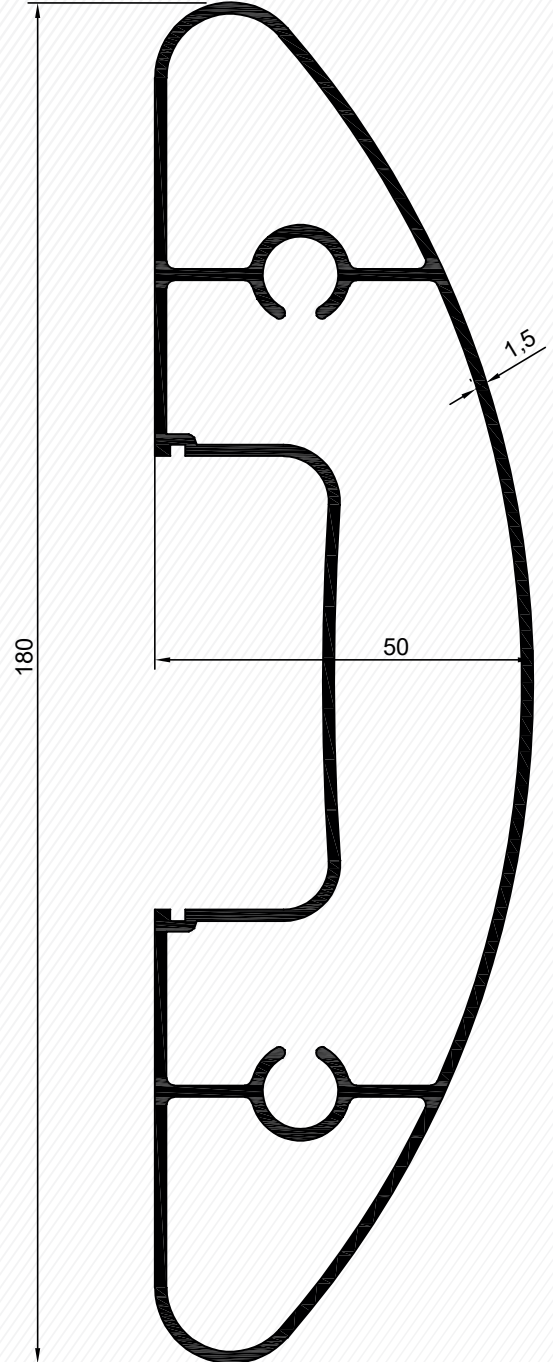
3540
2,517 kg/mt3541
2,235 kg/mt

Profiller / Profiles

3542

1,705 kg/mt

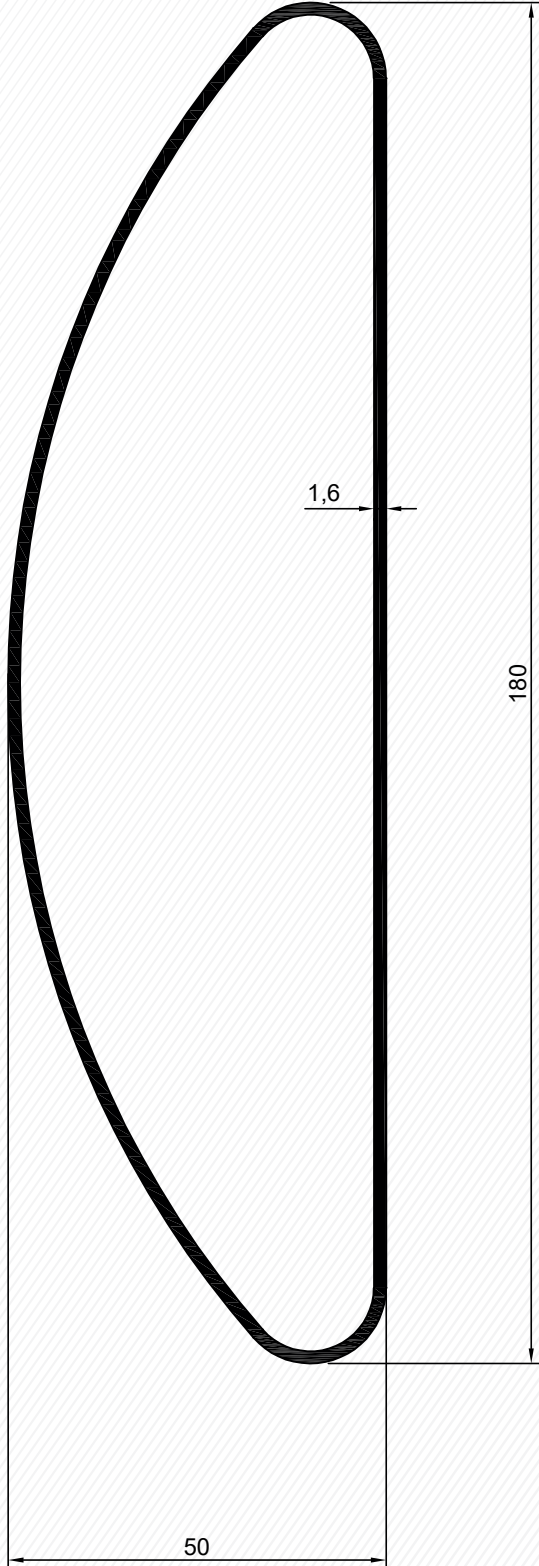

3543

1,850 kg/mt

