

ALKOR

ALUMINUM



YALITIMSIZ KAPI & PENCERE SİSTEMLERİ





UNINSULATED DOOR AND WINDOW SYSTEMS

- ALDOKS
- ALTEMA
- ALK 60
- ALK 5500
- ALK 45



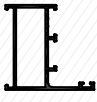
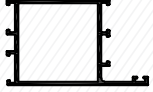
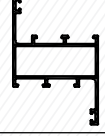

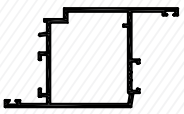
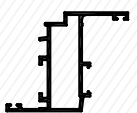
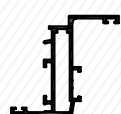
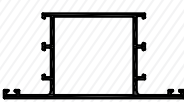

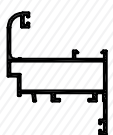
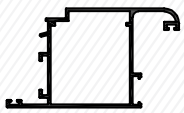

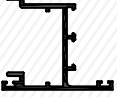

ALK 45

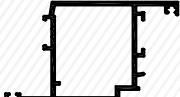

İçindekiler / Contents

Profil Profile	Profil Kodu Profile Nr	Ağırlık (kg/m.) Weight (kg/m.)	X mm.	Y mm.	J _x cm ⁴	J _y cm ⁴
	1423 Kasa Profili Frame Profile	0,728	45 mm	47,2 mm	8,13	3,11
	416 Kasa Profili Frame Profile	1,149	45 mm	74,5 mm	21,87	11,87
	2326 Kanat Profili Sash Profile	0,798	45 mm	67,2 mm	11,97	3,70
	1378 Orta Kayıt Profili Mullion Profile	0,883	45 mm	67,2 mm	8,80	7,15
	963 Kanat Profili Sash Profile	1,422	52,5 mm	91,44 mm	34,69	15,17
	964 Kanat Profili Sash Profile	0,935	52,5 mm	64,61 mm	34,69	15,17
	965 Kanat Profili Sash Profile	0,860	52,5 mm	57 mm	13,17	2,19
	417 Orta Kayıt Profili Mullion Profile	1,285	45 mm	95,2 mm	28,62	14,85
	1433 Kanat Profili Sash Profile	0,847	52,5 mm	57 mm	13,30	2,70
	1434 Kanat Profili Sash Profile	0,985	52,5 mm	64,61 mm	17,20	4,23
	1431 Kanat Profili Sash Profile	1,276	52,5 mm	91,3 mm	34,18	14,08

İçindekiler / Contents

Profil Profile	Profil Kodu Profile Nr	Ağırlık (kg/m.) Weight (kg/m.)	X mm.	Y mm.	Jx cm ⁴	Jy cm ⁴
	418 Adaptör Profili Adapter Profile	0,968	49,6 mm	58,4 mm	---	---
	1379 Kanat Profili Sash Profile	0,859	52,5 mm	57 mm	13,17	2,19
	1388 Kanat Profili Sash Profile	0,960	52,5 mm	64,61 mm	16,71	3,95
	1383 Kanat Profili Sash Profile	1,451	52,5 mm	91,64 mm	36,91	15,21
	420 Adaptör Profili Adapter Profile	0,345	42,45 mm	23,3 mm	---	---
	1381 Baza Profili Kick Plate Profile	2,207	45 mm	170 mm	---	---
	1325 Tij Profili Rod Profile	0,125	19,5 mm	4,3 mm	---	---
	1380 Çita Profili Bead Glazing Prf.	0,319	29 mm	20 mm	---	---
	1382 Çita Profili Bead Glazing Prf.	0,230	11 mm	20 mm	---	---
	1424 Çita Profili Bead Glazing Prf.	0,239	15 mm	20 mm	---	---
	1432 Çita Profili Bead Glazing Prf.	0,214	13 mm	20 mm	---	---

Profiller / Profiles

Kasa Profili - Frame Profile

1423
0,728 kg/mt

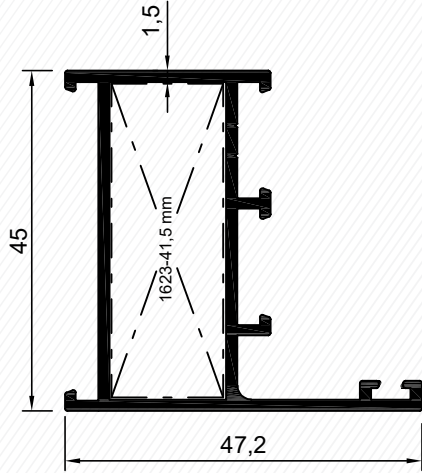

1423

Kasa Profili - Frame Profile

416
1,149 kg/mt

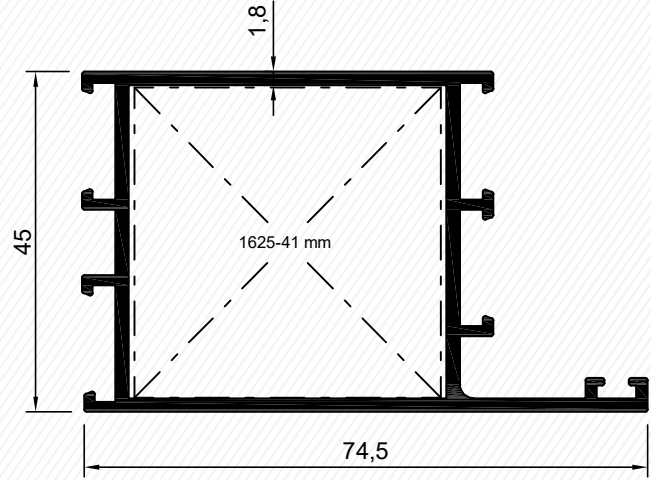

416

Kod	Et Kalın.	Ürün Adı	Ağırlığı	Köşe Takozu
1423	1,5 mm	Kasa Profili	0,728 kg/mt	1623-41,50
416	1,8 mm	Kasa Profili	1,149 kg/mt	1625-41

Kanat Profili - Sash Profile

2326
0,798 kg/mt

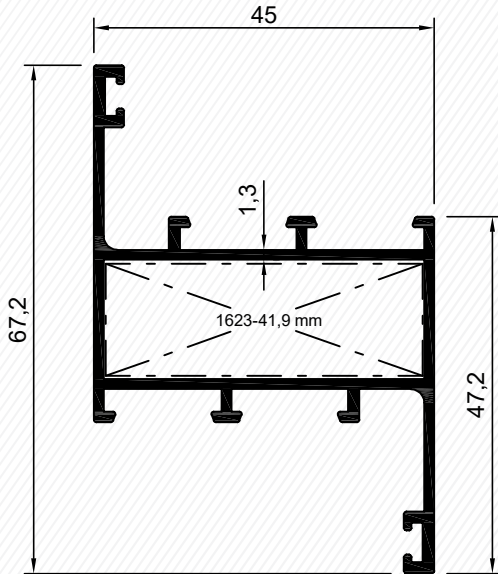

2326

Orta Kayıt Profili - Mullion Profiles

1378
0,883 kg/mt

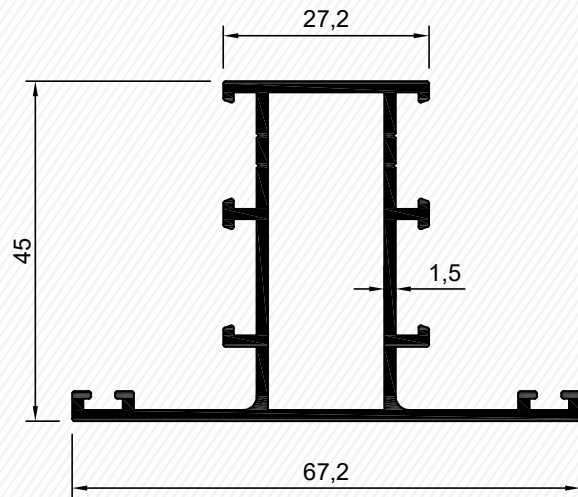

1378

Kod	Et Kalın.	Ürün Adı	Ağırlığı	Köşe Takozu
2326	1,3 mm	Kasa Profili	0,798 kg/mt	1623-41,90
1378	1,5 mm	Orta Kayıt Profili	0,883 kg/mt	400-15

Profiller / Profiles

Kanat Profili - Sash Profile

963

1,422 kg/mt

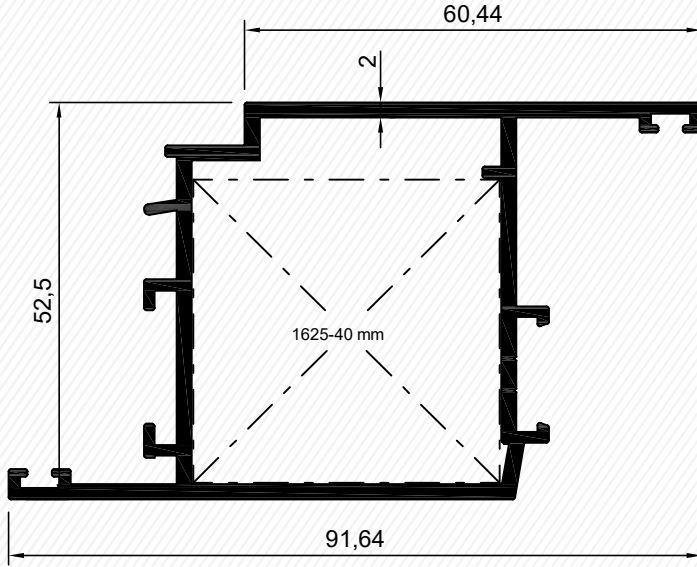
963

Kanat Profili - Sash Profile

964

0,935 kg/mt

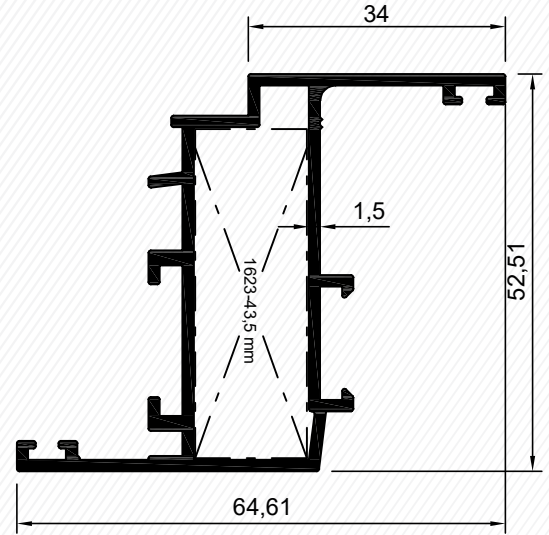

964

Kod	Et Kalın.	Ürün Adı	Ağırlığı	Köşe Takozu
963	2,0 mm	Kanat Profili	1,422 kg/mt	1625-40
964	1,5 mm	Kanat Profili	0,935 kg/mt	1623-43,5

Kanat Profili - Sash Profile

965

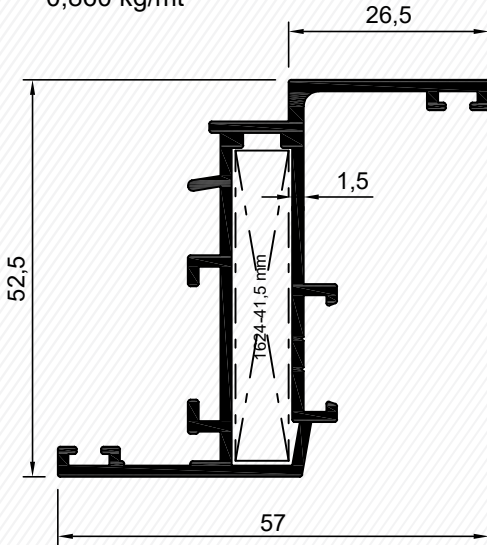
0,860 kg/mt

965

Orta Kayıt Profili - Mullion Profiles

417

1,285 kg/mt

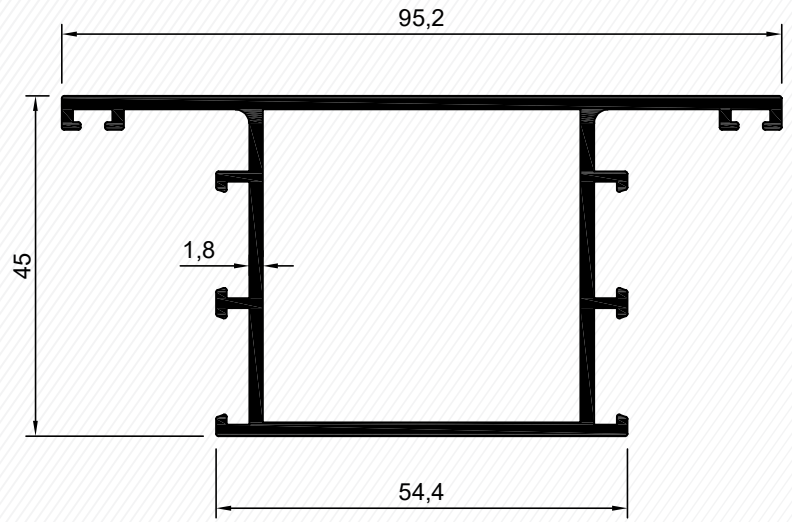
417

Kod	Et Kalın.	Ürün Adı	Ağırlığı	Köşe Takozu
965	1,5 mm	Kanat Profili	0,860 kg/mt	1624-41,50
417	1,8 mm	Orta Kayıt Profili	1,285 kg/mt	400-41,50

Profiller / Profiles

Kanat Profili - Sash Profile

1433

0,847 kg/mt

Kanat Profili - Sash Profile

1434

0,983 kg/mt

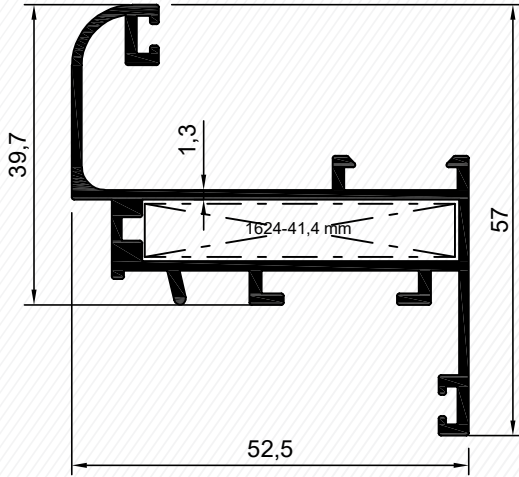

1433

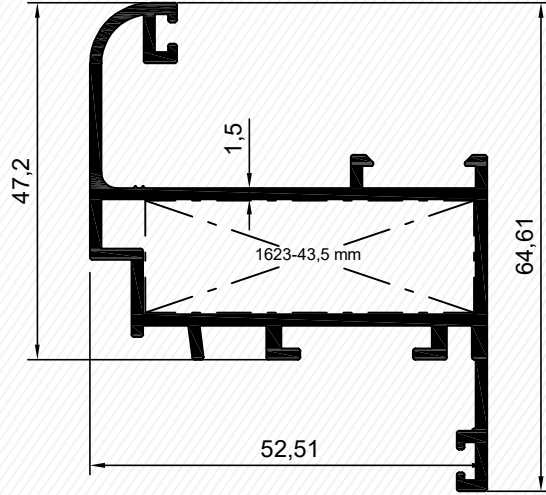

1434

Kod	Et Kalın.	Ürün Adı	Ağırlığı	Köşe Takozu
1433	1,3 mm	Kanat Profili	0,847 kg/mt	1624-41,4 mm
1434	1,5 mm	Kanat Profili	0,983 kg/mt	1623-43,5 mm

Kanat Profili - Sash Profile

1431

1,276 kg/mt

Çift Kanat Adaptörü - Adapter Profile

418

0,968 kg/mt

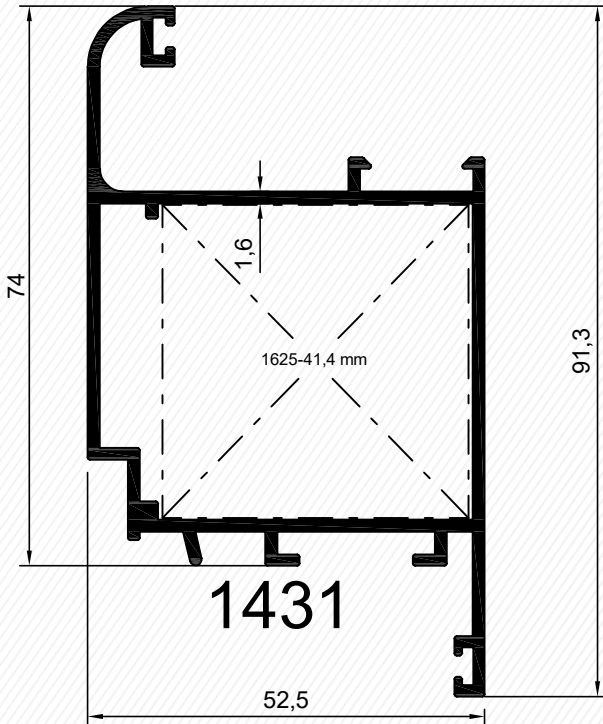

1431

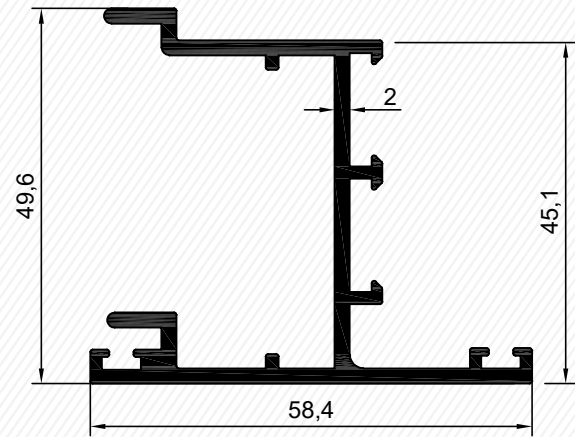

418

Kod	Et Kalın.	Ürün Adı	Ağırlığı	Köşe Takozu
1431	1,6 mm	Kanat Profili	1,276 kg/mt	1625-41,4 mm
418	2,0 mm	Adaptör Profili	0,968 kg/mt	

Profiller / Profiles

Kanat Profili - Sash Profile

1379

0,859 kg/mt

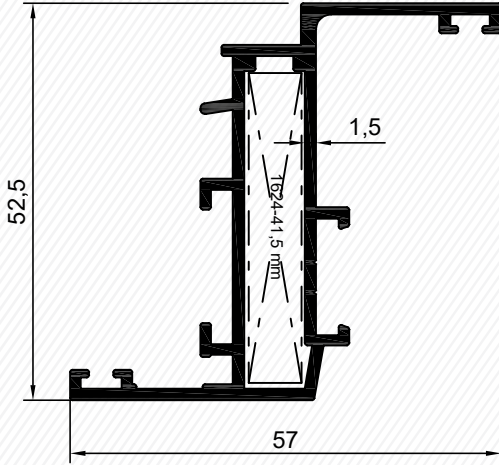
1379

Kanat Profili - Sash Profile

1388

0,959 kg/mt

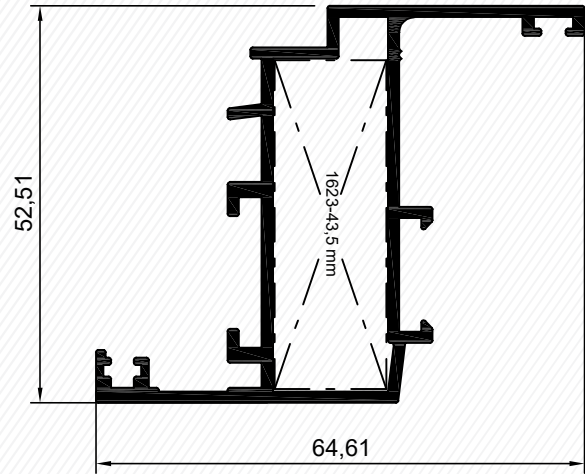

1388

Kod	Et Kalın.	Ürün Adı	Ağırlığı	Köşe Takozu
1379	1,5 mm	Kanat Profili	0,859 kg/mt	1624-41,5 mm
1388	1,5 mm	Kanat Profili	0,960 kg/mt	1623-43,5 mm

Kanat Profili - Sash Profile

1383

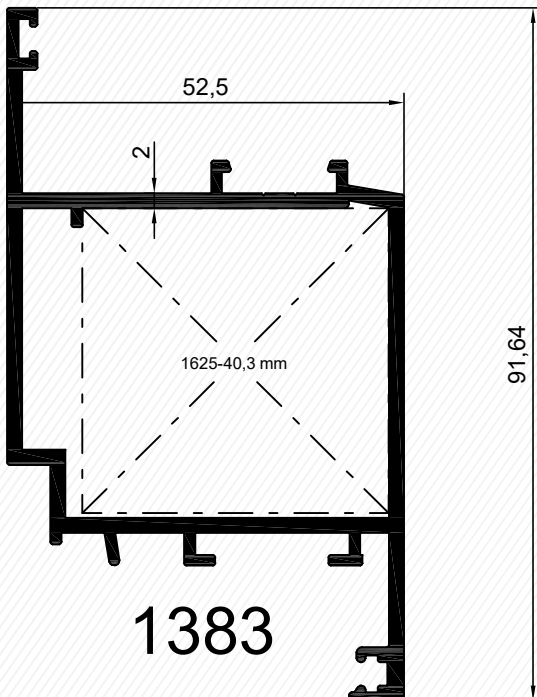
1,451 kg/mt

1383

Adaptör Profili - Adapter Profile

420

0,345 kg/mt

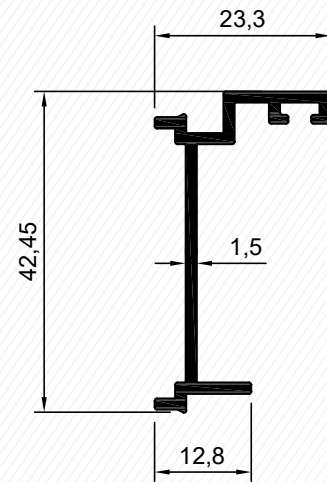
420

Kod	Et Kalın.	Ürün Adı	Ağırlığı	Köşe Takozu
1383	2 mm	Kanat Profili	1,451 kg/mt	1625-40,3 mm
420	1,5 mm	Adaptör Profili	0,345 kg/mt	

Profiller / Profiles

Baza Profili - Kick Plate Profile

1381

2,207 kg/mt

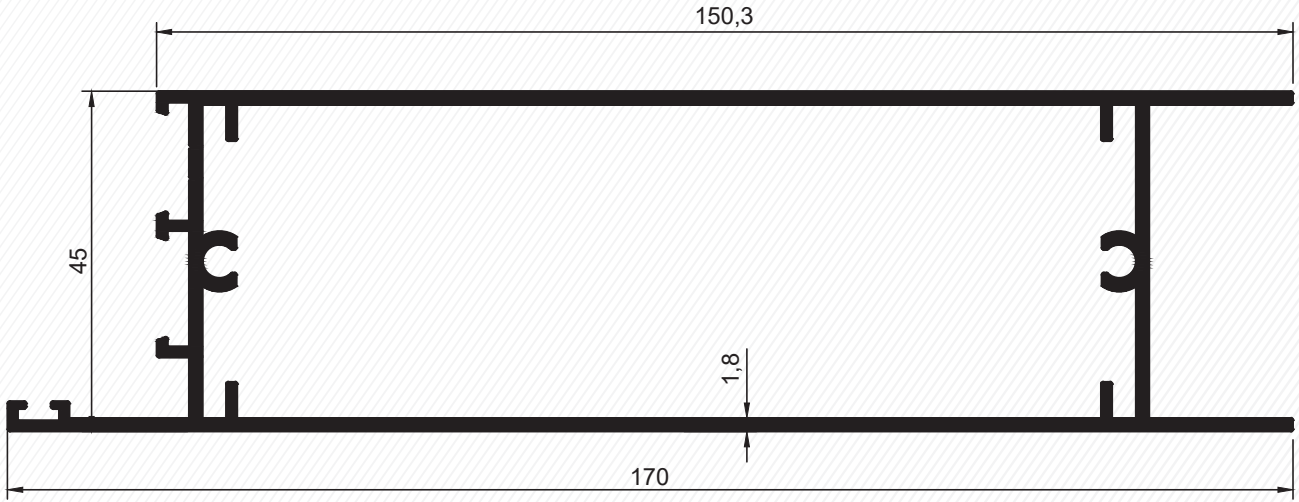

1381

Kod	Et Kalın.	Ürün Adı	Ağırlığı
1381	1,8 mm	Baza Profili	2,207 kg/mt

Tij Profili - Rod Profile

1325

0,125 kg/mt

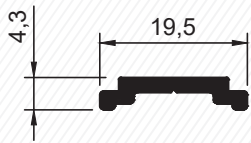

1325

Çıta Profili - Bead Glazing Profile

1380

0,319 kg/mt

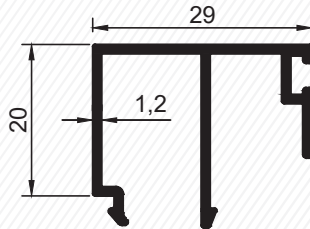

1380

Çıta Profili - Bead Glazing Profile

1382

0,230 kg/mt

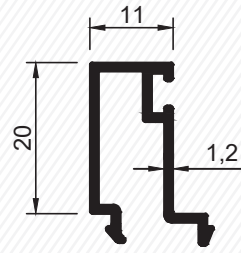

1382

Çıta Profili - Bead Glazing Profile

1424

0,239 kg/mt

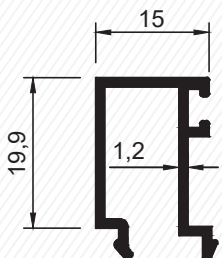

1424

Çıta Profili - Bead Glazing Profile

1432

0,214 kg/mt

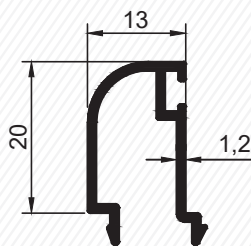

1432

Kod	Et Kalın.	Ürün Adı	Ağırlığı
1325		Tij Profili	0,125 kg/mt
1380	1,2 mm	Çıta Profili	0,319 kg/mt
1382	1,2 mm	Çıta Profili	0,230 kg/mt
1424	1,2 mm	Çıta Profili	0,239 kg/mt
1432	1,2 mm	Çıta Profili	0,214 kg/mt

Detaylar / Details

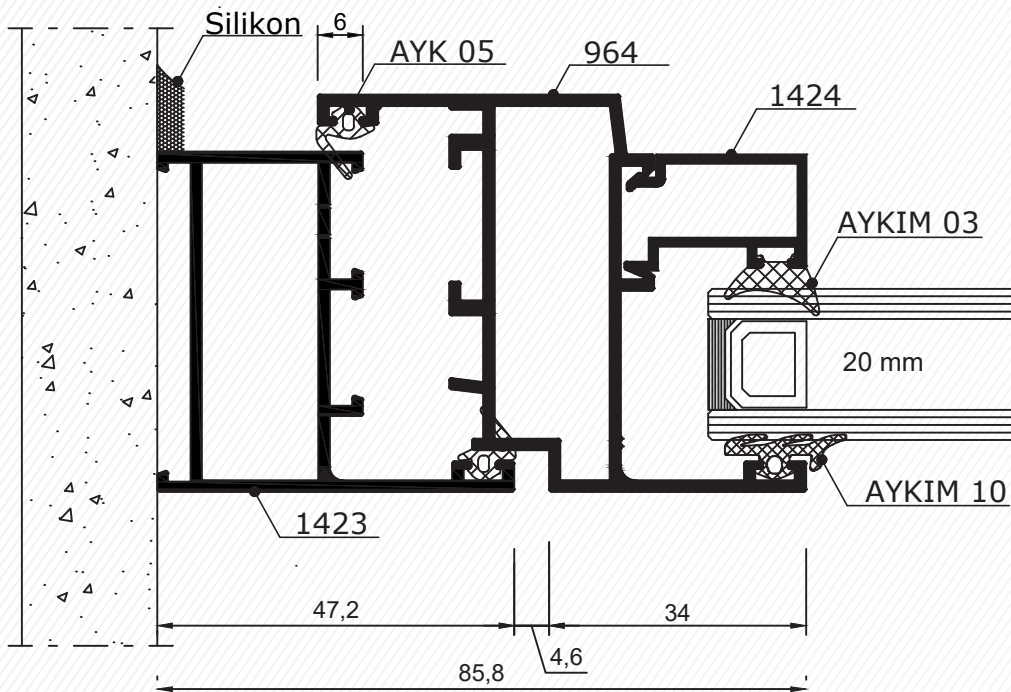
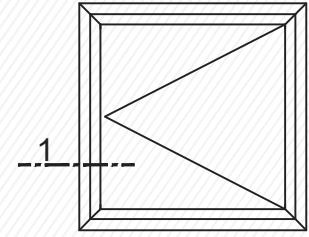
1 DETAYI
DETAIL

Ölçek: 1:1 / Scale: 1:1



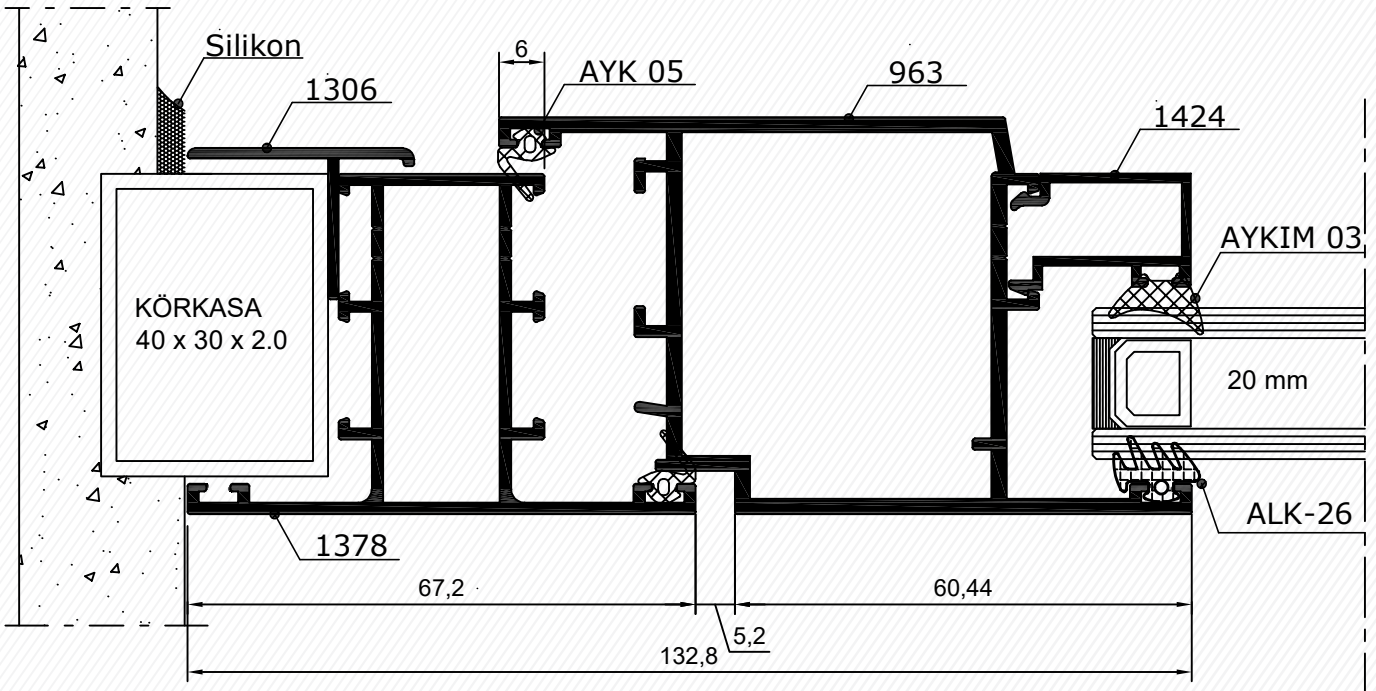
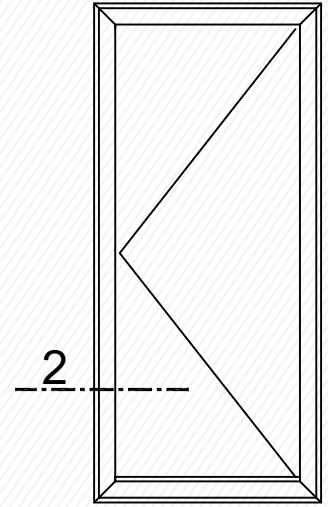







Detaylar / Details



2 DETAYI
DETAIL

Ölçek: 1:1 / Scale: 1:1

Aksesuarlar / Accessories

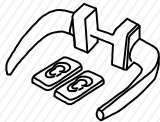
Ürün Çizimi Drawing	Ürün Kodu Product No	Ürün Adı Product Name	Kullanıldığı Profiller Profiles Used
	1623	45° Köşe Takozu Joint Corner	1423-2326-964-1434-1388
	1624	45° Köşe Takozu Joint Corner	965-1433-1379
	1625	45° Köşe Takozu Joint Corner	416-964-1431-1383
	400	90° Bağlantı Takozu Joint Corner	1378-417
	AYK 05	Bini Fiteli 4 mm Brush For Frame	963-964-965-1433-1434- 1431-1379-1388-1383
	AYKIM 03	Cam Fiteli 4 mm Brush	1380-1382-1424-1432
	ALK-26	Cam Fiteli 4 mm Brush	963-964-965-1433-1434- 1431-1379-1388-1383
	153-01-055 153-01-056 153-01-057	Eksenel Kol Window Handle 055-Eloksal, 056-Renkli, 057-Beyaz 055-Anodizing, 056-Color, 057-White	963-964-965-1433-1434- 1431-1379-1388-1383
	153-01-063 153-01-064 153-01-065	Menteşe Hinge 063-Eloksal, 064-Renkli, 065-Beyaz 063-Anodized, 064-Color, 065-White	963-964-965-1433-1434- 1431-1379-1388-1383
	153-01-129	Sistem Zamak Karşılığı Plate System Support	963-964-965-1433-1434- 1431-1379-1388-1383
	153-01-052 153-01-053 153-01-054	Milenyum Kapı Kolu Handle For Door 052-Gümüş, 053-Renkli, 054-Beyaz 052-Silver, 053-Color, 054-White	963-964-965-1433-1434- 1431-1379-1388-1383