

# ALKOR

ALUMINUM



## YALITIMSIZ KAPI & PENCERE SİSTEMLERİ

UNINSULATED DOOR AND WINDOW SYSTEMS

- ALDOKS
- ALTEMA
- ALK 60
- ALK 5500
- ALK 45

## ALK 60



## İçindekiler / Contents

Profil Profile	Profil Kodu Profile No	Ağırlık (kg/m.) Weight (kg/m.)	X mm.	Y mm.	Jx cm <sup>4</sup>	Jy cm <sup>4</sup>
	3716 Kasa Profili Frame Profile (1,5 mm)	1,017	60 mm.	49 mm.	18,60	11,93
	5632 Kasa Profili Frame Profile (1,9 mm)	1,218	60 mm.	49 mm.	22,09	13,67
	3725 Kanat Profili Sash Profile (1,5 mm)	1,074	60 mm.	66 mm.	22,64	14,11
	5633 Kanat Profili Sash Profile (1,9 mm)	1,285	60 mm.	66 mm.	26,30	16,21
	3727 Kasa Profili Frame Profile	0,777	60 mm.	19,5 mm.	---	---
	3714 Kasa Profili Frame Profile	1,416	60 mm.	98 mm.	68,31	31,18
	3709 Baza Profili Kick Plate Profile	1,917	60 mm.	133 mm.	138,31	46,39
	8377A Baza Profili Kick Plate Profile	1,911	60 mm.	133 mm.	137,77	46,37
	3715 Köşe Dönüş Profili Corner Profile	1,110	60 mm.	60 mm.	---	---
	3711 Adaptör Profili Adapter Profile	0,438	57,48 mm.	24 mm.	---	---
	3710 Adaptör Profili Adapter Profile	0,435	60 mm.	12,5 mm.	---	---

## İçindekiler / Contents

Profil Profile	Profil Kodu Profile No	Ağırlık (kg/m.) Weight (kg/m.)	X mm.	Y mm.	J <sub>x</sub> cm <sup>4</sup>	J <sub>y</sub> cm <sup>4</sup>
	3726 Adaptör Profili Adapter Profile	0,411	60 mm.	16,3 mm.	---	---
	3647 Adaptör Profili Adapter Profile	0,350	60 mm.	12,1 mm.	---	---
	1334 Çıta Profili Glazing Bead Profile	0,247	23,5 mm.	17 mm.	---	---
	8378A Çıta Profili Glazing Bead Profile	0,262	23,5 mm.	17 mm.	---	---
	1336 Çıta Profili Glazing Bead Profile	0,202	18,8 mm.	22,2 mm.	---	---
	1350 Çıta Profili Glazing Bead Profile	0,330	39,3 mm.	22 mm.	---	---
	1351 Çıta Profili Glazing Bead Profile	0,341	32,3 mm.	22 mm.	---	---
	1376 Çıta Profili Glazing Bead Profile	0,281	18,4 mm.	22 mm.	---	---
	3737 Çıta Profili Glazing Bead Profile	0,247	23,5 mm.	17 mm.	---	---

Profiller / Profiles

Kasa Profili - Frame Profile

3716  
1,017 kg/mt

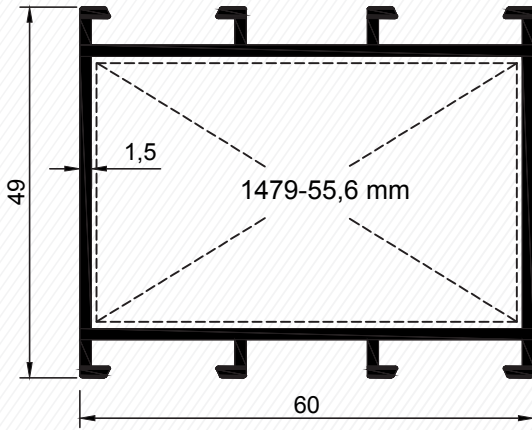

3716

Kasa Profili - Frame Profile

5632  
1,223 kg/mt

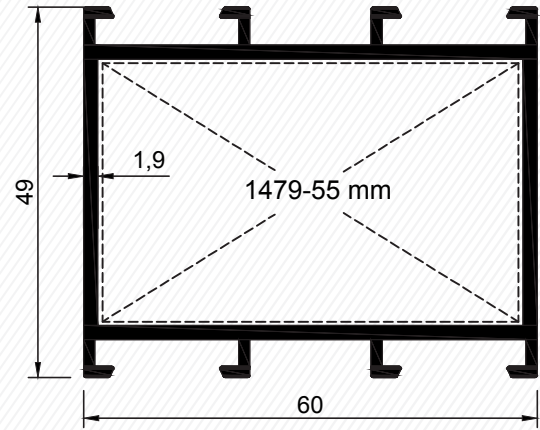

5632

Kod	Et Kalın.	Ürün Adı	Ağırlığı	Köşe Takozu
3716	1,5 mm	Kasa Profili	1,017 kg/mt	1479-55,6 mm
5632	1,9 mm	Kasa Profili	1,218 kg/mt	1479-55 mm

Kanat Profili - Sash Profile

3725  
1,074 kg/mt

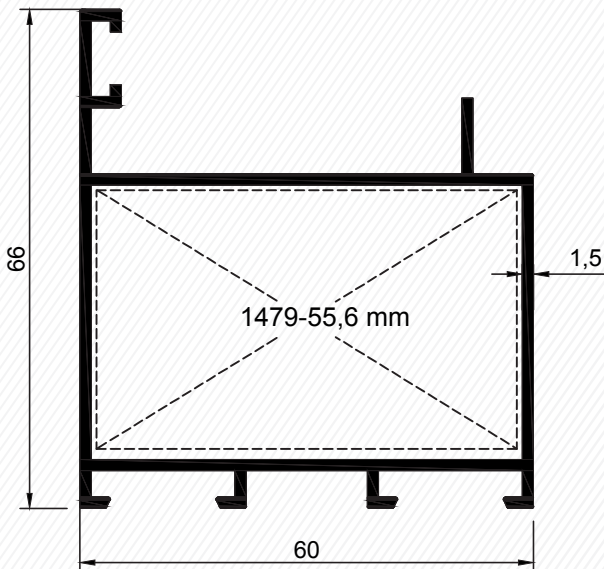

3725

Kanat Profili - Sash Profile

5633  
1,285 kg/mt

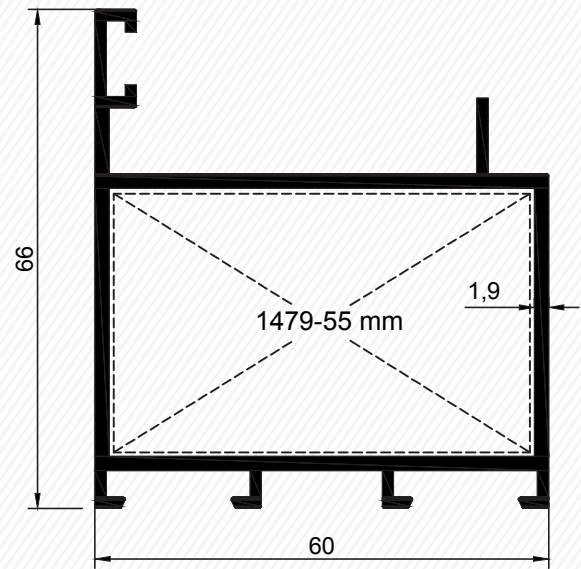

5633

Kod	Et Kalın.	Ürün Adı	Ağırlığı	Köşe Takozu
3725	1,5 mm	Kanat Profili	1,074 kg/mt	1479-55,6 mm
5633	1,9 mm	Kanat Profili	1,285 kg/mt	1479-55 mm

**Profiller / Profiles**

Geniş Kasa Profili - Frame Profile

3714

1,416 kg/mt

Dar Kasa Profili - Frame Profile

3727

0,777 kg/mt

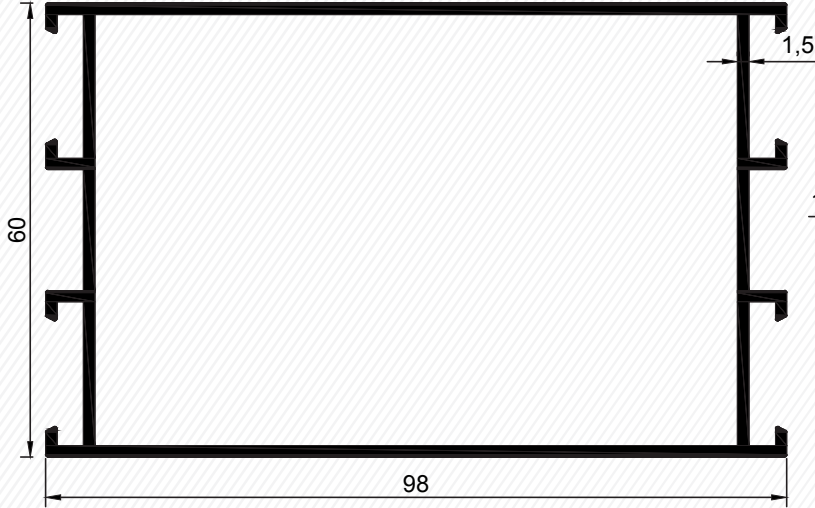
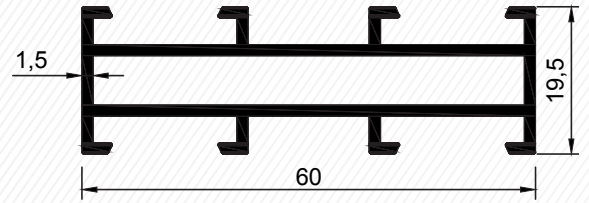
**3714**

**3727**

Kod	Et Kalın.	Ürün Adı	Ağırlığı	Köşe Takozu
3714	1.5 mm	Geniş Kasa Profili	1,416 kg/mt	153-02-293
3727	1.5 mm	Dar Kasa Profili	0,777 kg/mt	

Köşe Dönüş Profili - Corner Profile

3715

1,110 kg/mt

Adaptör Profili - Adapter Profile

3711

0,438 kg/mt

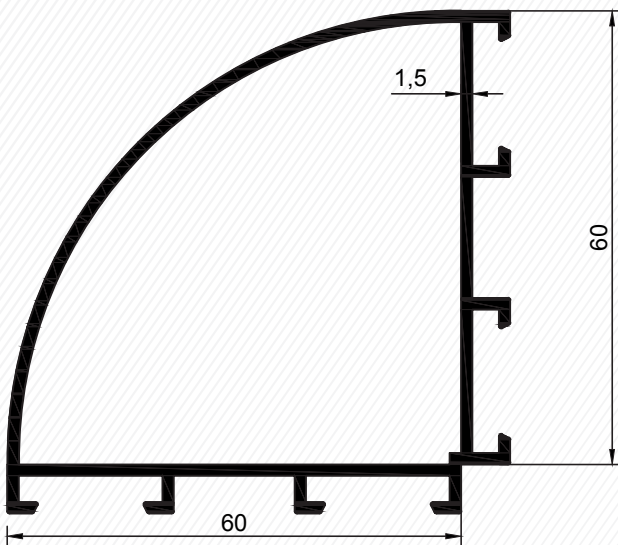
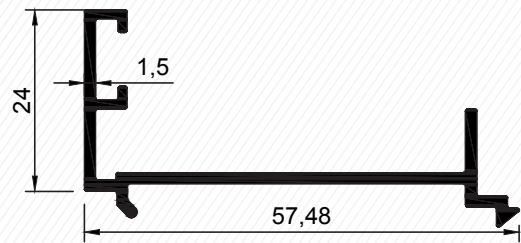
**3715**

**3711**

Kod	Et Kalın.	Ürün Adı	Ağırlığı	Köşe Takozu
3715	1.5 mm	Köşe Dönüş Profili	1,110 kg/mt	
3711	1.5 mm	Adaptör Profili	0,438 kg/mt	

Profiller / Profiles

Baza Profili - Kick Plate Profile

3709  
1,416 kg/mt

Baza Profili - Kick Plate Profile

8377A  
0,777 kg/mt

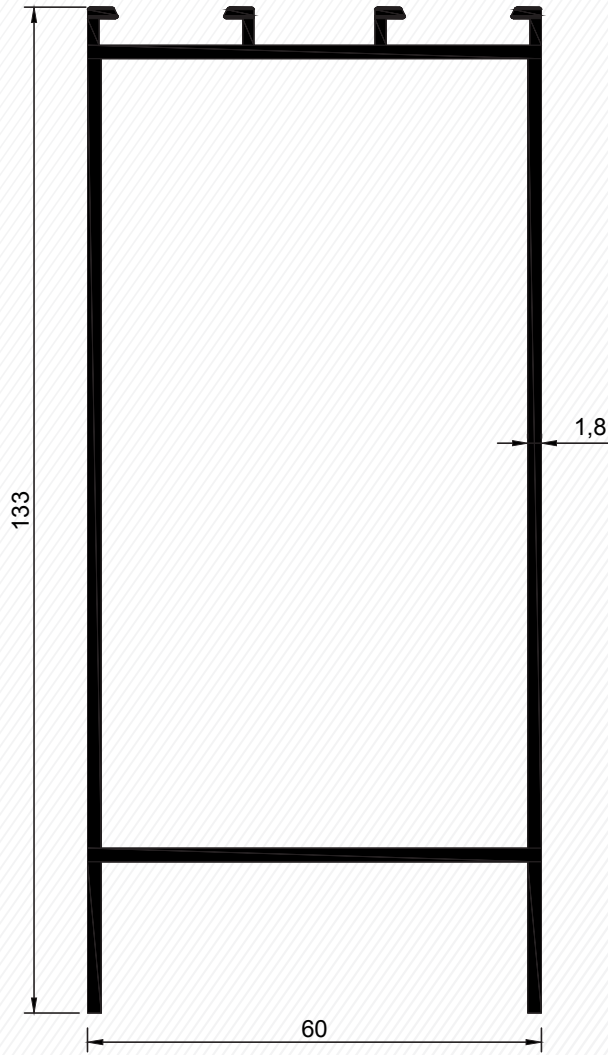

3709

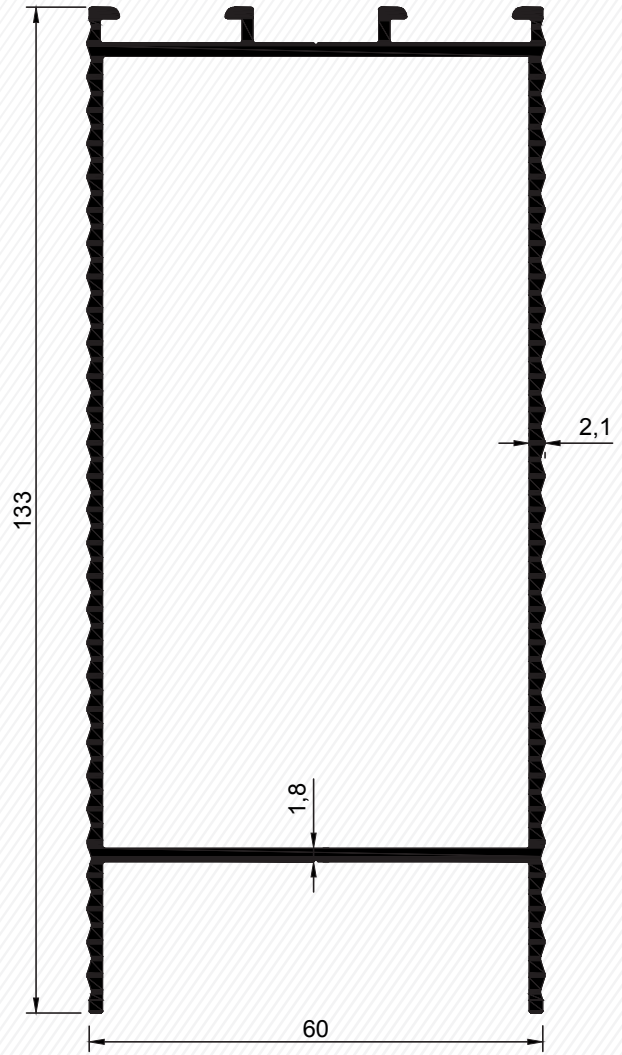

8377A

Kod	Et Kalın.	Ürün Adı	Ağırlığı	Köşe Takozu
3709	1.8 mm	Baza Profili	1,917 kg/mt	153-02-293
8377A	1.8 mm	Baza Profili	1,911 kg/mt	153-02-293

**Profiller / Profiles**

Adaptör Profili - Adapter Profile

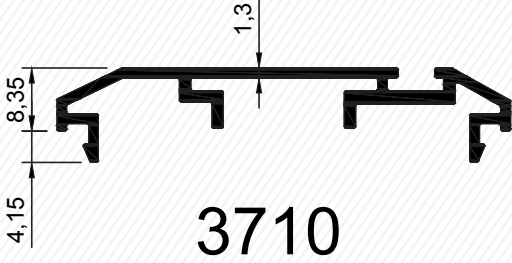
 3710  
 0,435 kg/mt

**3710**

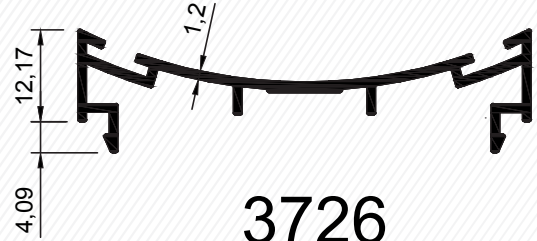
Adaptör Profili - Adapter Profile

 3726  
 0,411 kg/mt

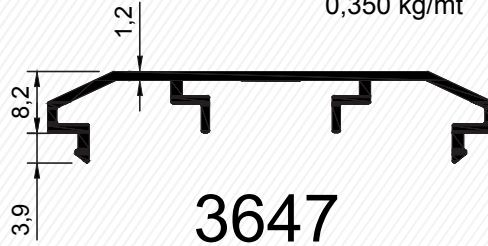
**3726**

Adaptör Profili - Adapter Profile

 3647  
 0,350 kg/mt

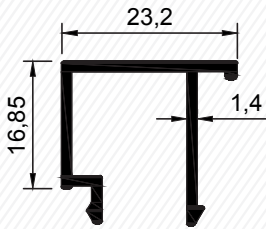
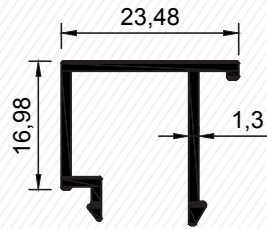
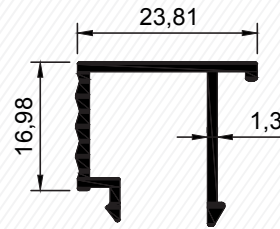
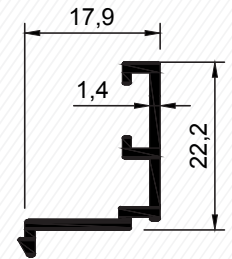
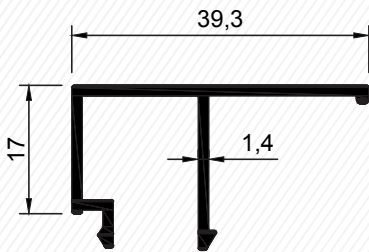
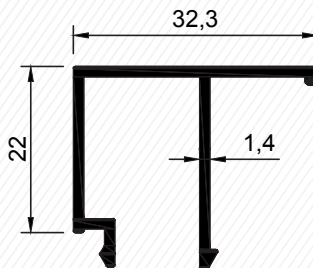
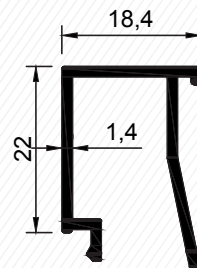
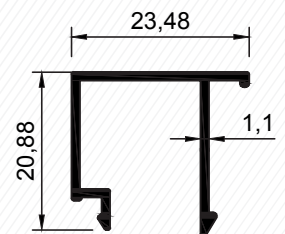
**3647**

Cam Çıtası Profili - Glazing Bead Profile

**1334**  
 (0,247 kg/mt)

**3737**  
 (0,247 kg/mt)

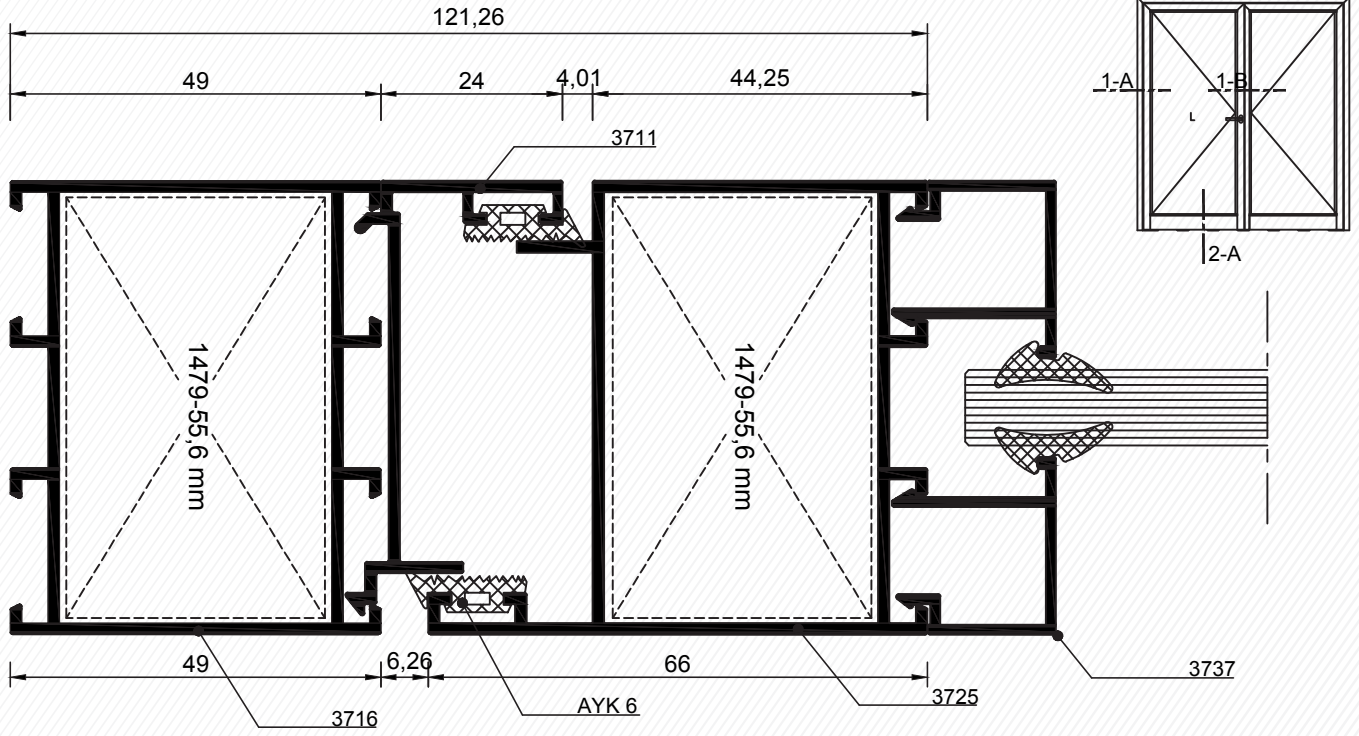
**8378A**  
 (0,262 kg/mt)

**1336**  
 (0,202 kg/mt)

**1350**  
 (0,330 kg/mt)

**1351**  
 (0,341 kg/mt)

**1376**  
 (0,281 kg/mt)

**6621**  
 (0,210 kg/mt)



Detaylar / Details



1-A DETAYI  
DETAIL

Ölçek: 1:1 / Scale: 1:1

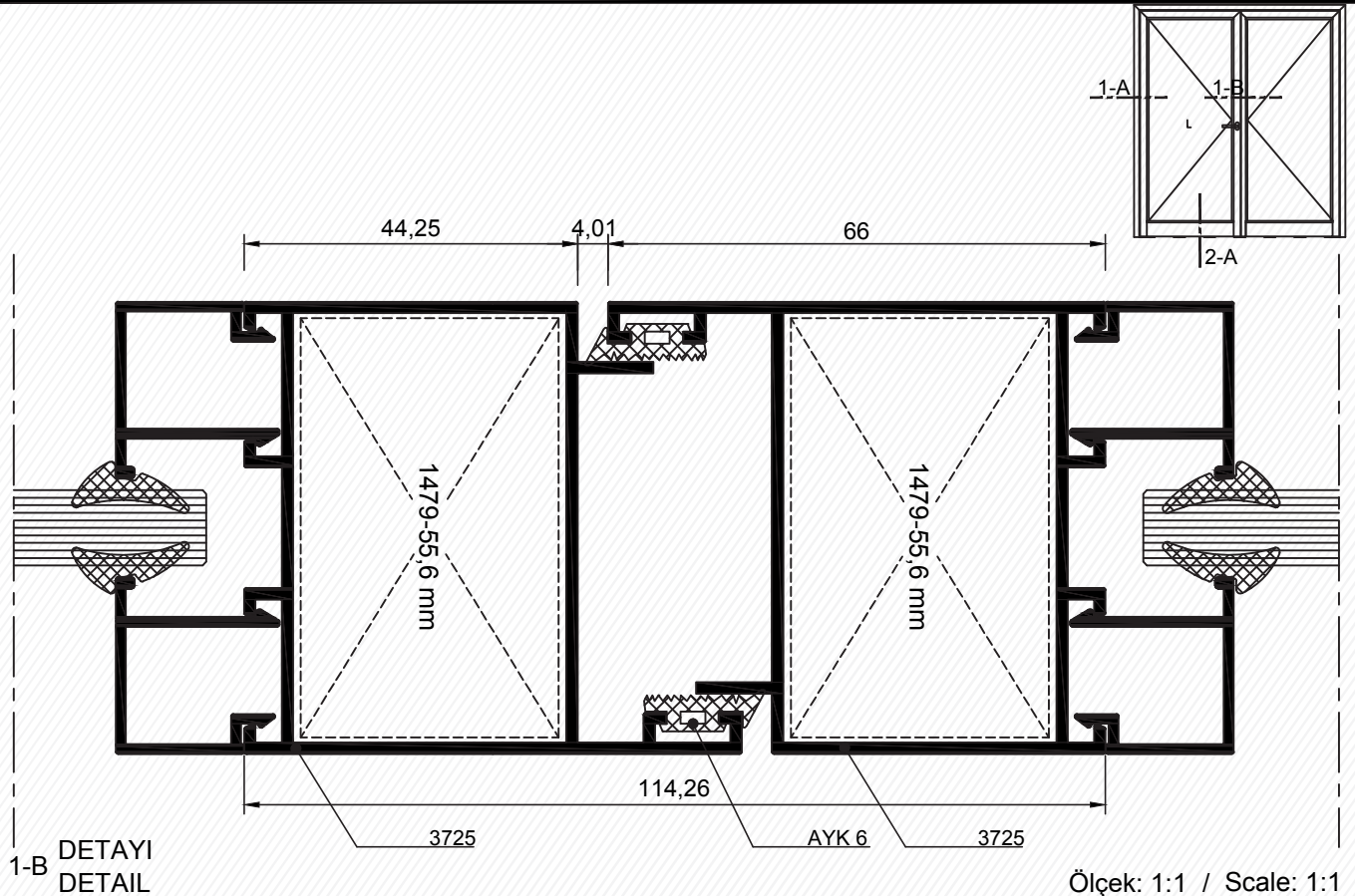

1-B DETAYI  
DETAIL

Ölçek: 1:1 / Scale: 1:1

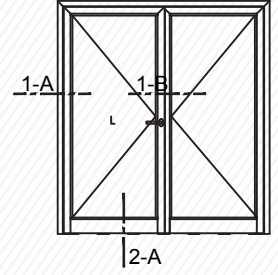
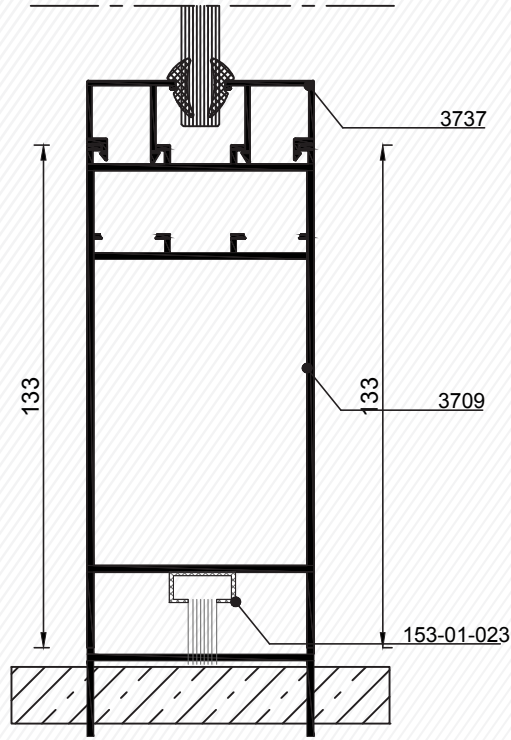
**Detaylar / Details**

 2-A DETAYI  
 DETAIL

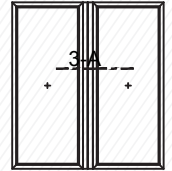
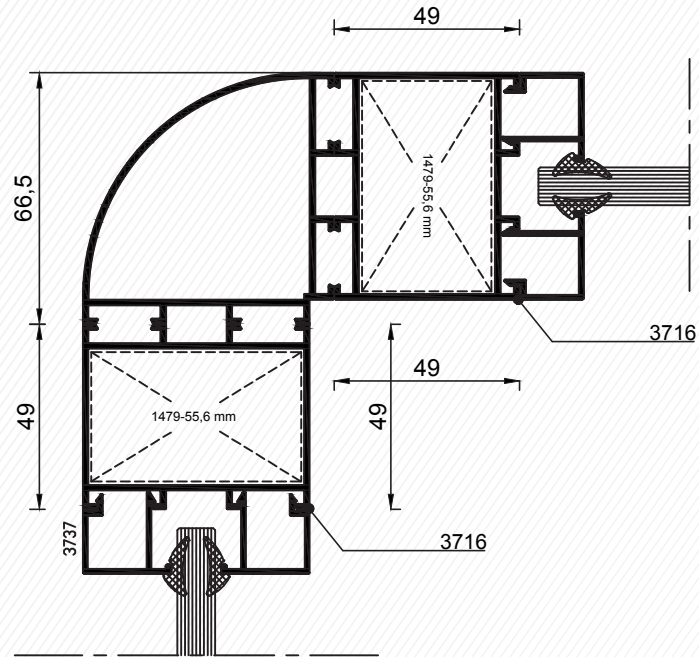
Ölçek: 1:2 / Scale: 1:2

 3-A DETAYI  
 DETAIL

Ölçek: 1:2 / Scale: 1:2

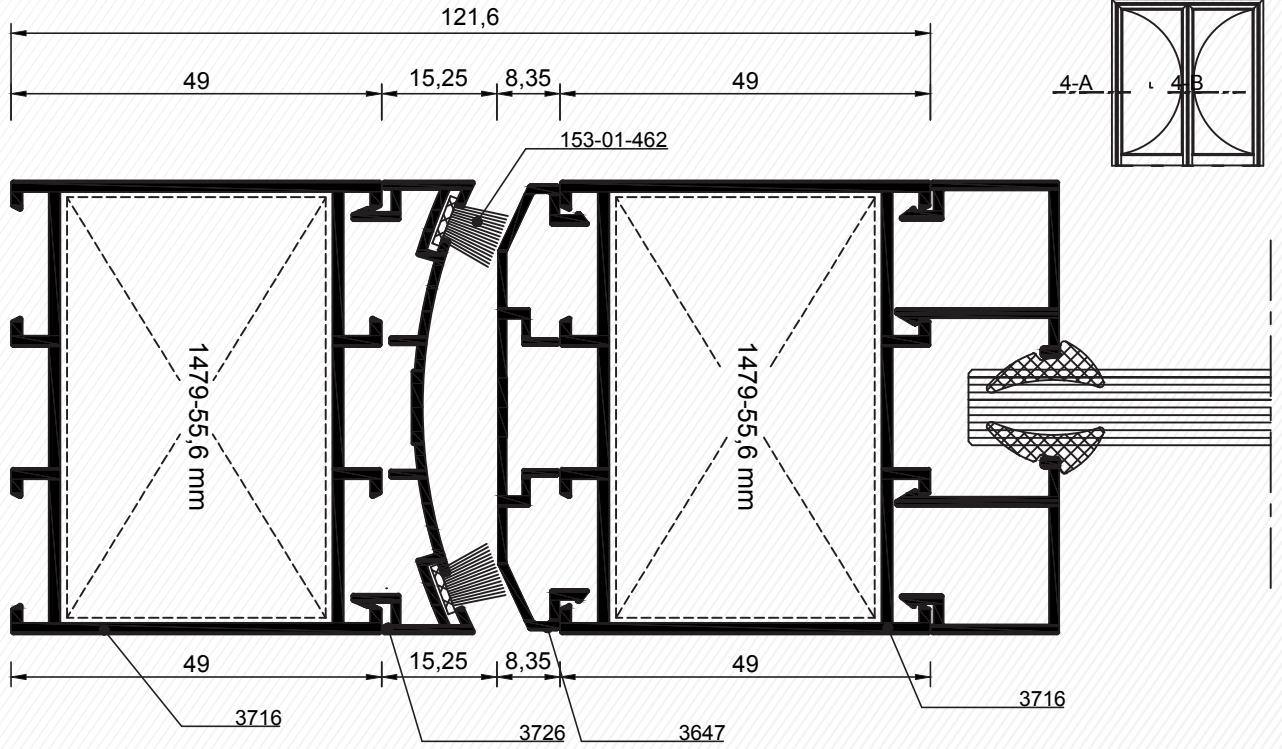
Detaylar / Details



4-A DETAYI  
DETAIL



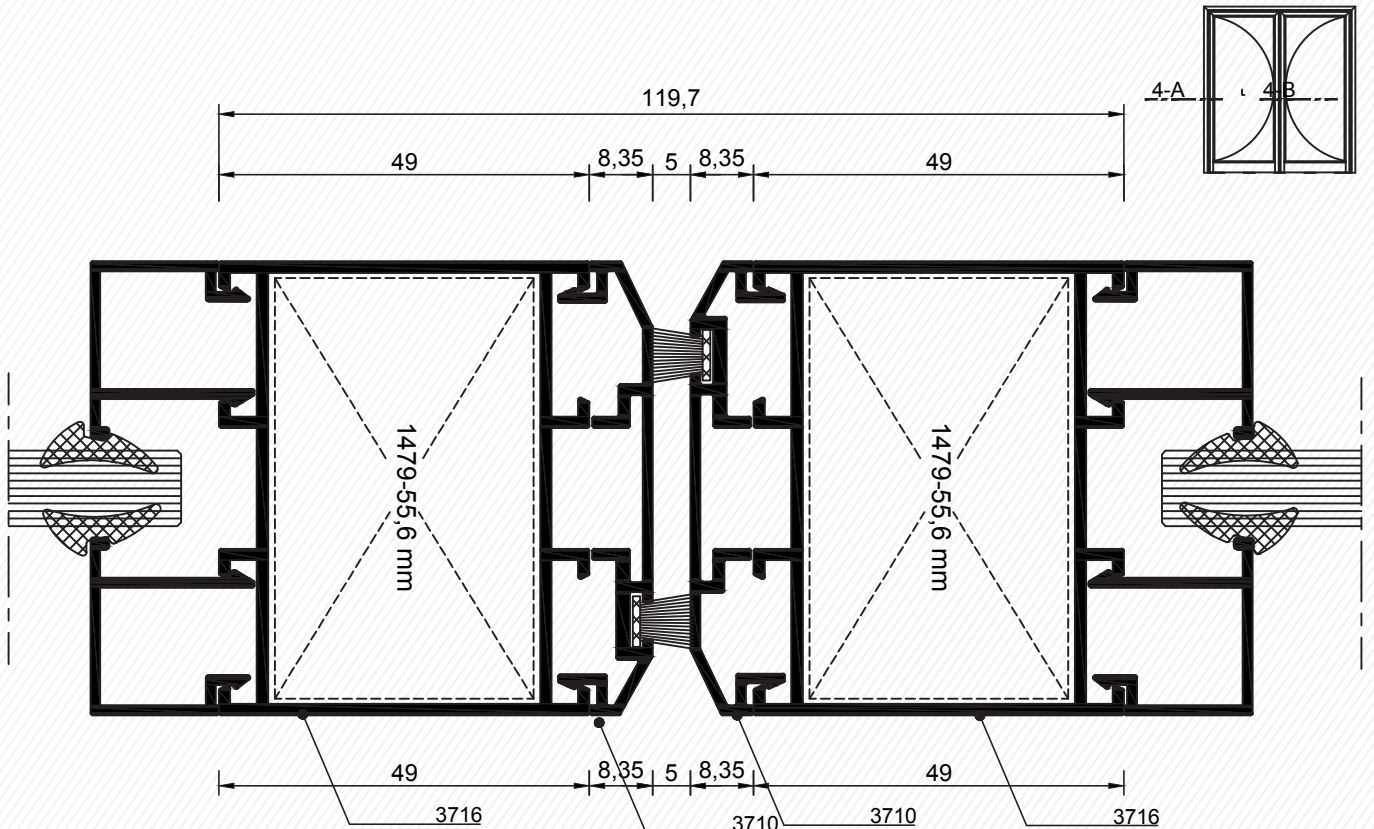



Ölçek: 1:2 / Scale: 1:2

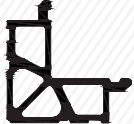
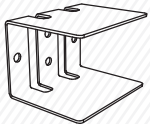
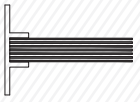

4-B DETAYI  
DETAIL

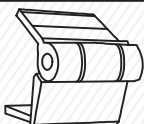
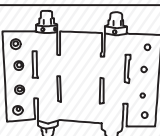
Ölçek: 1:1 / Scale: 1:1

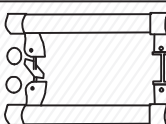
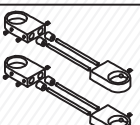
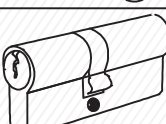
### Aksesuarlar / Accessories

Ürün Çizimi Drawing	Ürün Kodu Product No	Ürün Adı Product Name	Kullanıldığı Profiller Profiles Used
	1395-35,5 mm	90° Bağlantı Takozu Joint Corner	3714-3716-3709
	1479-55,6 mm	45° Press Köşe Takozu Joint Corner	3716-3725
	153-02-293	90° Bağlantı Takozu Joint Corner	3714-3716-3709
	153-01-023	Kapı Altı Fırça Brush For Doors	3709
	153-01-010 153-01-011 153-01-012	Menteşe Hinge 010-Renkli 011-Beyaz 012-Gümüş 010-Color 011-White 012-Silver	3716-3725
	153-01-263 153-01-264 153-01-265	Yarma Mentеше Hinge 263-Gümüş 264-Renkli 265-Beyaz 263-Silver 264-Color 265-White	3716-3725
	153-02-034	Çarpma Kapı Mentешesi Swing Door Hinge	3716-3725
	153-01-052 153-01-053 153-01-054	Milenyum Kapı Kolu Handle For Door 052-Gümüş, 053-Renkli, 054-Beyaz 052-Silver, 053-Color, 054-White	3725
	153-02-483 153-02-799	Akbank Kol Borusu Bow Handle 02-483-Eloksal, 02-799-Renkli 02-483-Silver, 02-799-Color	3725
	153-01-022 153-02-483	Akbank Kol Aparatı Bow Handle 01-022-Eloksal, 02-472-Renkli 01-022-Silver, 02-472-Color	3725
	153-01-032	164-GNC 76 mm Barel Cylinder Barrel Lock Door	3725
	153-01-326	153 /25 U Boş Kasa Dilli Kilit Mortise Lock	3725



**Aknometri / Acnometry**

