

# ALKOR

ALUMINUM



## YALITIMSIZ KAPI & PENCERE SİSTEMLERİ











UNINSULATED DOOR AND WINDOW SYSTEMS

- ALDOKS
- ALTEMA
- ALK 60
- ALK 5500
- ALK 45





# ALDOKS





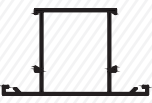
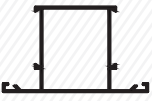
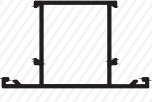

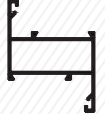
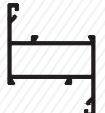

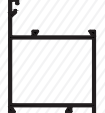
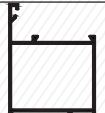

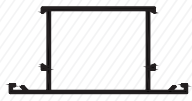

**İçindekiler / Contents**

Profil Profile	Profil Kodu Profile Nr	Ağırlık (kg/m.) Weight (kg/m.)	X mm.	Y mm.	J <sub>x</sub> cm <sup>4</sup>	J <sub>y</sub> cm <sup>4</sup>
	6631 Kasa Profili Frame Profile (1,1 mm)	0,510	45,5 mm.	42 mm.	---	---
	1086 Kasa Profili Frame Profile (1,2 mm)	0,542	45,5 mm.	42 mm.	---	---
	1343 Kasa Profili Frame Profile (1,4 mm)	0,632	45,5 mm.	42 mm.	---	---
	1154 Kasa Profili Frame Profile (1,8 mm)	0,795	45,5 mm.	42 mm.	---	---
	6634 Kasa Profili Frame Profile (1,1 mm)	0,615	45,5 mm.	60 mm.	---	---
	1090 Kasa Profili Frame Profile (1,2 mm)	0,674	45,5 mm.	60 mm.	---	---
	1346 Kasa Profili Frame Profile (1,4 mm)	0,768	45,5 mm.	60 mm.	---	---
	1453 Kasa Profili Frame Profile (2 mm)	1,035	45,5 mm.	60 mm.	---	---
	6630 Orta Kayıt Profili Middle Transom Pr. (1,1 mm)	0,610	45,5 mm.	59 mm.	---	---
	1084 Orta Kayıt Profili Middle Transom Pr. (1,2 mm)	0,667	45,5 mm.	59 mm.	---	---
	1341 Orta Kayıt Profili Middle Transom Pr. (1,4 mm)	0,752	45,5 mm.	59 mm.	---	---









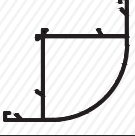

## İçindekiler / Contents

Profil Profile	Profil Kodu Profile Nr	Ağırlık (kg/m.) Weight (kg/m.)	X mm.	Y mm.	Jx cm <sup>4</sup>	Jy cm <sup>4</sup>
	1152 Orta Kayıt Profili Middle Transom Pr. (1,8 mm)	0,936	45,5 mm.	59 mm.	---	---
	6633 Orta Kayıt Profili Middle Transom Pr. (1,1 mm)	0,715	45,5 mm.	77 mm.	---	---
	1088 Orta Kayıt Profili Middle Transom Pr. (1,2 mm)	0,753	45,5 mm.	77 mm.	---	---
	1344 Orta Kayıt Profili Middle Transom Pr. (1,4 mm)	0,788	45,5 mm.	77 mm.	---	---
	1121 Orta Kayıt Profili Middle Transom Pr. (2 mm)	1,163	45,5 mm.	77 mm.	---	---
	6629 Kanat Profili Sash Profile (1,1 mm)	0,610	45,5 mm.	59 mm.	---	---
	1085 Kanat Profili Sash Profile (1,2 mm)	0,667	45,5 mm.	59 mm.	---	---
	1342 Kanat Profili Sash Profile (1,4 mm)	0,752	45,5 mm.	59 mm.	---	---
	1153 Kanat Profili Sash Profile (1,8 mm)	0,938	45,5 mm.	59 mm.	---	---
	6632 Kanat Profili Sash Profile (1,1 mm)	0,715	45,5 mm.	77 mm.	---	---
	1089 Kanat Profili Sash Profile (1,2 mm)	0,786	45,5 mm.	77 mm.	---	---

**İçindekiler / Contents**

Profil Profile	Profil Kodu Profile Nr	Ağırlık (kg/m.) Weight (kg/m.)	X mm.	Y mm.	J <sub>x</sub> cm <sup>4</sup>	J <sub>y</sub> cm <sup>4</sup>
	1345 Kanat Profili Sash Profile (1,4 mm)	0,888	45,5 mm.	77 mm.	---	---
	1122 Kanat Profili Sash Profile (2,0 mm)	1,165	45,5 mm.	77 mm.	---	---
	1104 Orta Kayıt Profili Middle Transom Pr. (1,5 mm)	1,079	45,5 mm.	94 mm.	---	---
	1111 Orta Kayıt Profili Middle Transom Pr. (1,5 mm)	1,202	45,5 mm.	110 mm.	---	---
	1116 Orta Kayıt Profili Middle Transom Pr. (1,5 mm)	1,443	45,5 mm.	138 mm.	---	---
	1117 Kanat Profili Sash Profile (1,5 mm)	1,215	45,5 mm.	110 mm.	---	---
	6635 Kanat Profili Sash Profile (1,5 mm)	1,215	45,5 mm.	110 mm.	---	---
	1103 Baza Profili Kick Plate Profile (1,5 mm)	1,170	45,5 mm.	100 mm.	---	---
	1100 Baza Profili Kick Plate Profile (1,4 mm)	1,242	45,5 mm.	120 mm.	---	---
	6636 Baza Profili Kick Plate Profile (1,5 mm)	1,335	45,5 mm.	120 mm.	---	---
	6637 Köşe Dönüş Prf. Corner Profile (1,2 mm)	0,760	65,5 mm.	65,5 mm.	---	---

## İçindekiler / Contents

Profil Profile	Profil Kodu Profile Nr	Ağırlık (kg/m.) Weight (kg/m.)	X mm.	Y mm.	J <sub>x</sub> cm <sup>4</sup>	J <sub>y</sub> cm <sup>4</sup>
	1008A Köşe Dönüş Prf. Corner Profile (1,2 mm)	0,964	65,5 mm.	65,5 mm.	---	---
	1505 Kasa Profili Frame Profile (1,2 mm)	0,431	40,5 mm.	42 mm.	---	---
	1011 Kasa Profili Frame Profile (1,2 mm)	0,318	45,5 mm.	23,1 mm.	---	---
	1130 Adaptör Profili Adapter Profile (1,5 mm)	0,378	44,8 mm.	16 mm.	---	---
	1131 Adaptör Profili Adapter Profile (1,5 mm)	0,296	44,8 mm.	12,5 mm.	---	---
	1004 Çıta Profili Glazing Bead Prf.	0,215	30 mm.	19,8 mm.	---	---
	6639 Çıta Profili Glazing Bead Prf.	0,230	29,2 mm.	16,8 mm.	---	---
	1010 Çıta Profili Glazing Bead Prf.	0,224	16,5 mm.	16,8 mm.	---	---
	1041 Tij Profili Rod Profile	0,095	22 mm.	4,4 mm.	---	---
	1042 Tij Profili Rod Profile	0,108	25 mm.	5 mm.	---	---

Profiller / Profiles

Dar Kasa Profili - Frame Profile

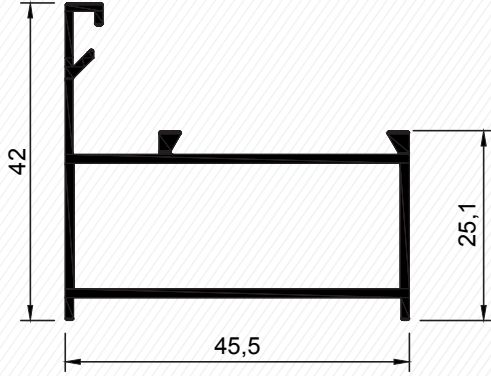

Geniş Kasa Profili - Frame Profile

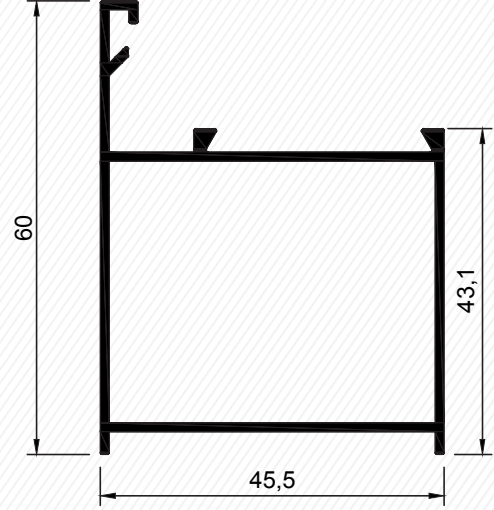

Kod	Et Kalın.	Ürün Adı	Ağırlığı
6631	1,1 mm	Kasa Profili	0,510 kg/mt
1086	1,2 mm	Kasa Profili	0,542 kg/mt
1343	1,4 mm	Kasa Profili	0,632 kg/mt
1154	1,8 mm	Kasa Profili	0,795 kg/mt

Kod	Et Kalın.	Ürün Adı	Ağırlığı
6634	1,1 mm	Kasa Profili	0,615 kg/mt
1090	1,2 mm	Kasa Profili	0,674 kg/mt
1346	1,4 mm	Kasa Profili	0,768 kg/mt
1453	2 mm	Kasa Profili	1,035 kg/mt

Orta Kayıt Profili - Middle Transom Profile

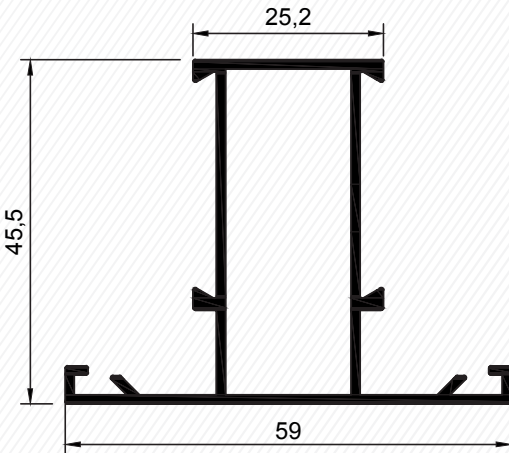

Orta Kayıt Profili - Middle Transom Profile

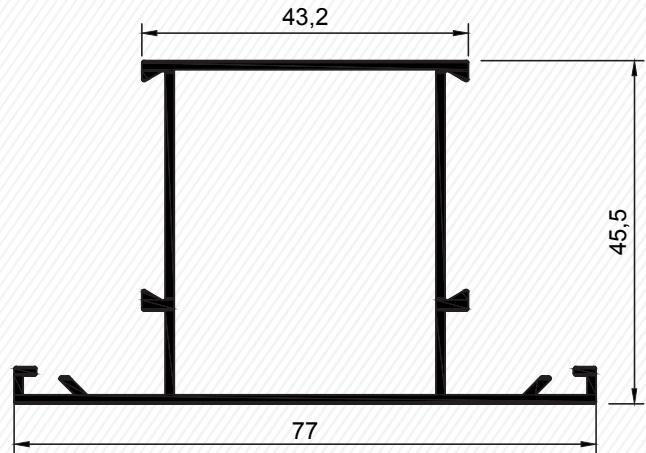

Kod	Et Kalın.	Ürün Adı	Ağırlığı
6630	1,1 mm	Orta Kayıt Profili	0,610 kg/mt
1084	1,2 mm	Orta Kayıt Profili	0,667 kg/mt
1341	1,4 mm	Orta Kayıt Profili	0,752 kg/mt
1152	1,8 mm	Orta Kayıt Profili	0,936 kg/mt

Kod	Et Kalın.	Ürün Adı	Ağırlığı
6633	1,1 mm	Orta Kayıt Profili	0,715 kg/mt
1088	1,2 mm	Orta Kayıt Profili	0,753 kg/mt
1344	1,4 mm	Orta Kayıt Profili	0,788 kg/mt
1121	2,0 mm	Orta Kayıt Profili	1,163 kg/mt

## Profiller / Profiles

Kanat Profili - Sash Profile

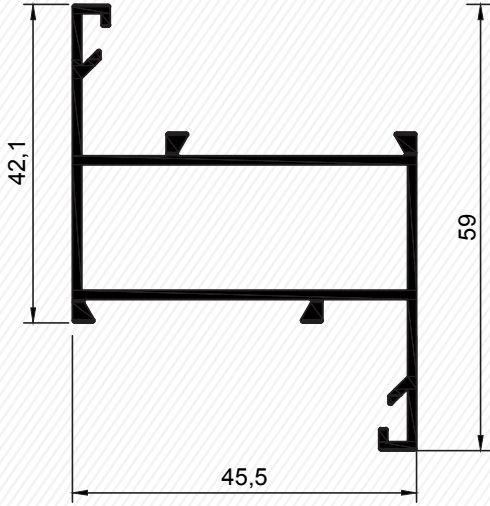

Kanat Profili - Sash Profile

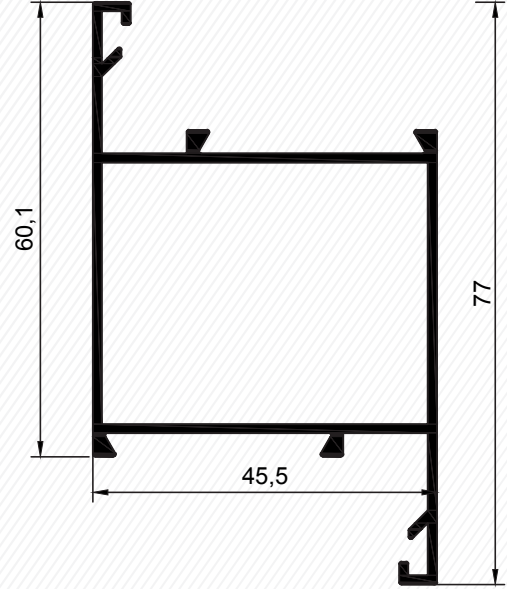

Kod	Et Kalın.	Ürün Adı	Ağırlığı
6629	1,1 mm	Kanat Profili	0,610 kg/mt
1085	1,2 mm	Kanat Profili	0,667 kg/mt
1342	1,4 mm	Kanat Profili	0,752 kg/mt
1153	1,8 mm	Kanat Profili	0,938 kg/mt

Kod	Et Kalın.	Ürün Adı	Ağırlığı
6632	1,1 mm	Kanat Profili	0,715 kg/mt
1089	1,2 mm	Kanat Profili	0,786 kg/mt
1345	1,4 mm	Kanat Profili	0,888 kg/mt
1122	2,0 mm	Kanat Profili	1,165 kg/mt

Orta Kayıt Profili - Middle Transom Profile

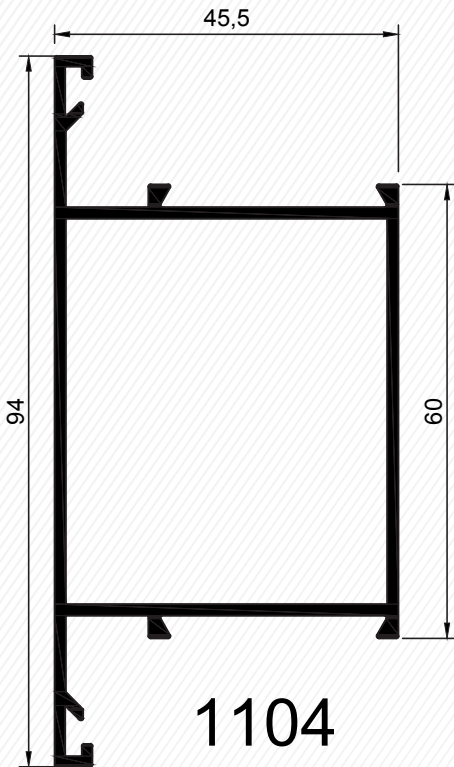

Kod	Et Kalın.	Ürün Adı	Ağırlığı
1104	1,5 mm	Duble T Profili	1,079 kg/mt

Orta Kayıt Profili - Middle Transom Profile

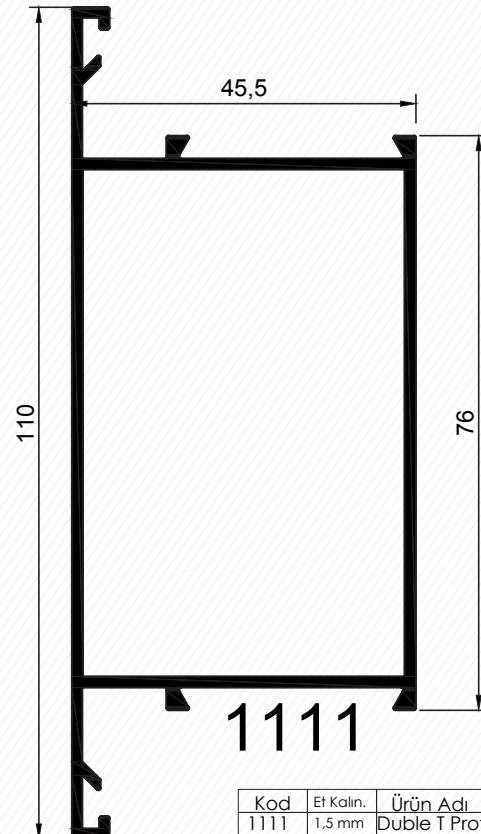

Kod	Et Kalın.	Ürün Adı	Ağırlığı
1111	1,5 mm	Duble T Profili	1,202 kg/mt



Profiller / Profiles

Orta Kayıt Profili - Middle Transom Profile

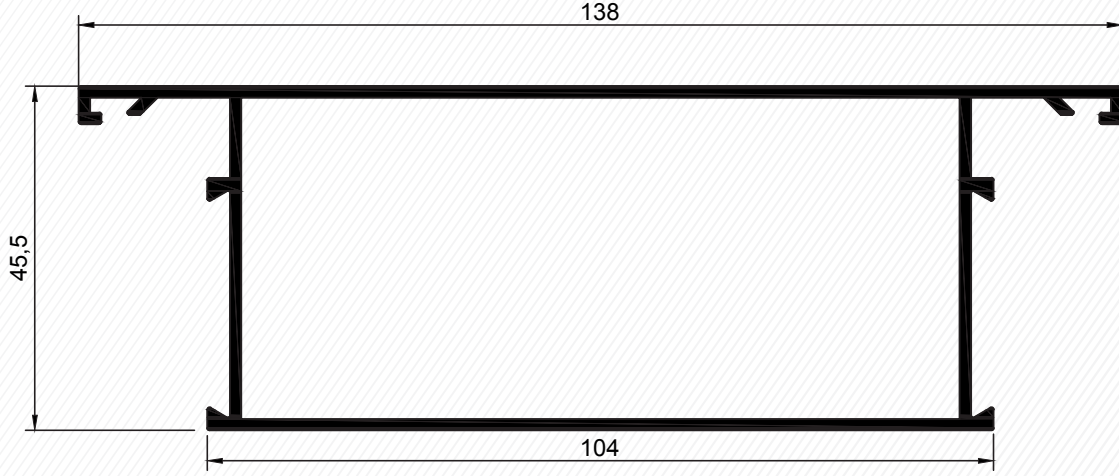

1116

Kod	Et Kalın.	Ürün Adı	Ağırlığı
1116	1,5 mm	Duble T Profili	1,443 kg/mt

Kanat Profili - Sash Profile

Kanat Profili - Sash Profile

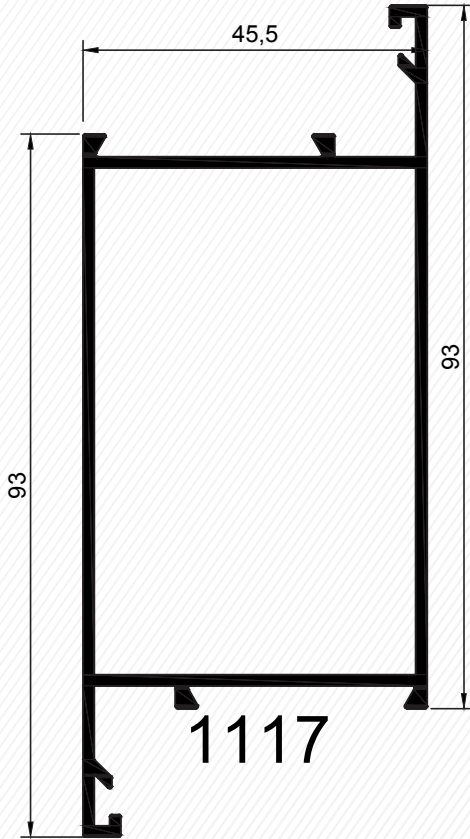

1117

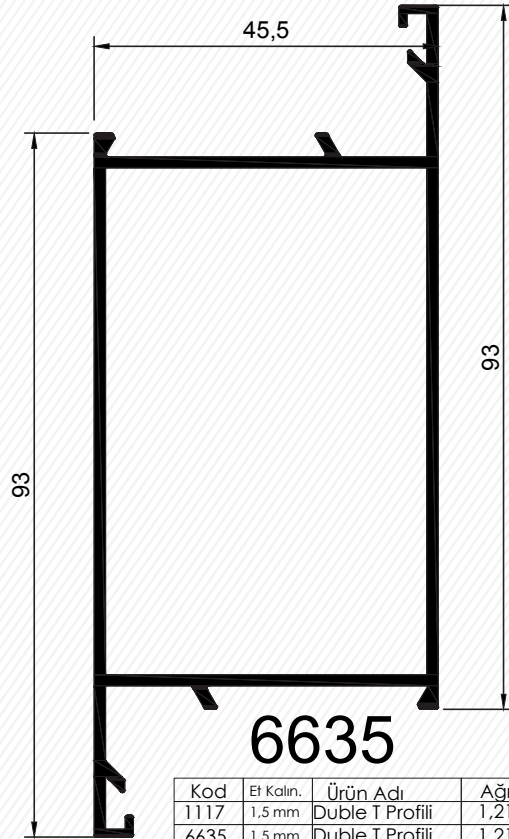

6635

Kod	Et Kalın.	Ürün Adı	Ağırlığı
1117	1,5 mm	Duble T Profili	1,215 kg/mt
6635	1,5 mm	Duble T Profili	1,215 kg/mt

**Profiller / Profiles**

Baza Profili - Kick Plate Profile

Köşe Dönüş Profili - Corner Profile

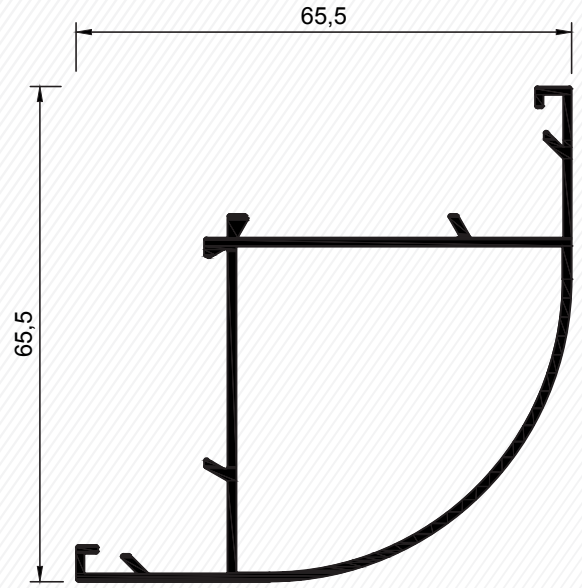
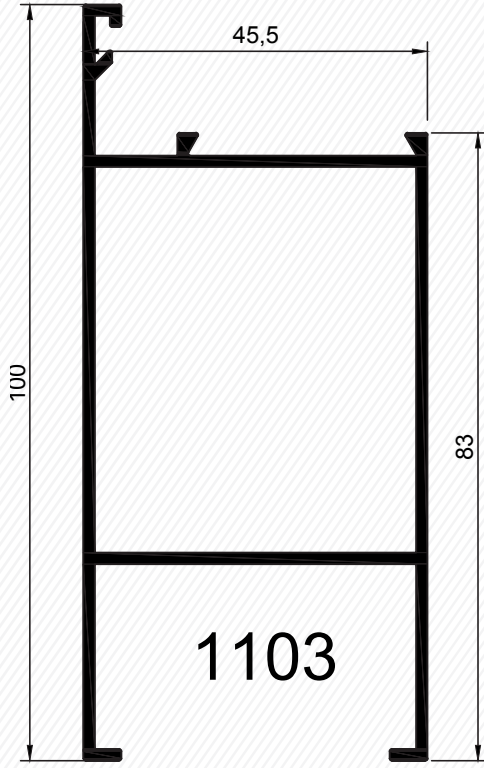

Kod	Et Kalın.	Ürün Adı	Ağırlığı
1103	1,5 mm	Baza Profili	1,170 kg/mt

Kod	Et Kalın.	Ürün Adı	Ağırlığı
6637	1,2 mm	Köşe Dönüş Profili	0,760 kg/mt
1008A	1,6 mm	Köşe Dönüş Profili	0,964 kg/mt

Baza Profili - Kick Plate Profile

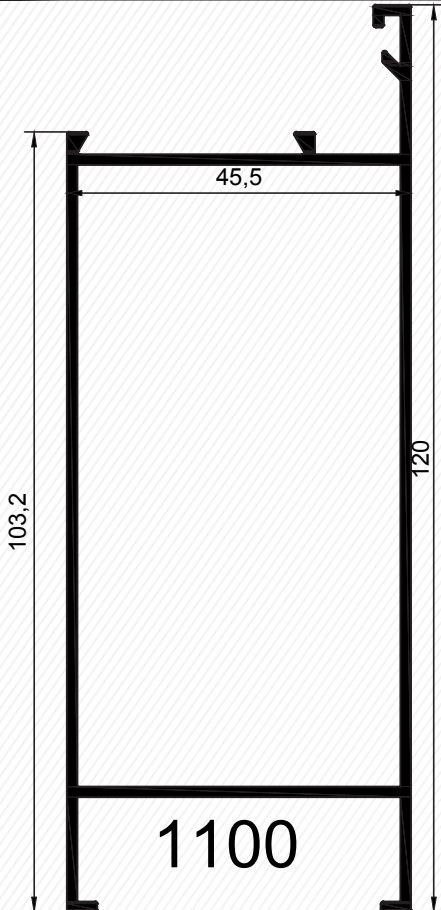

Kod	Et Kalın.	Ürün Adı	Ağırlığı
1100	1,4 mm	Baza Profili	1,242 kg/mt
6636	1,5 mm	Baza Profili	1,335 kg/mt

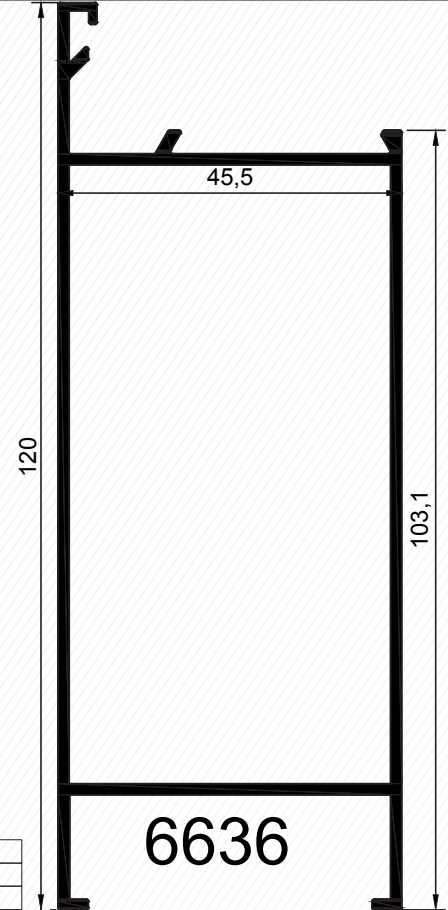

Profiller / Profiles

Çarpma Kapi Adaptör Profili - Adapter Profile

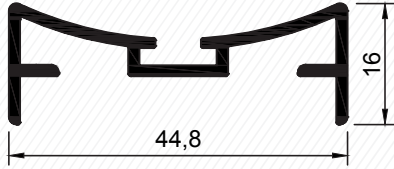

**1130**

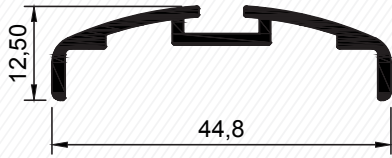

**1131**

Kasa Profili - Frame Profile

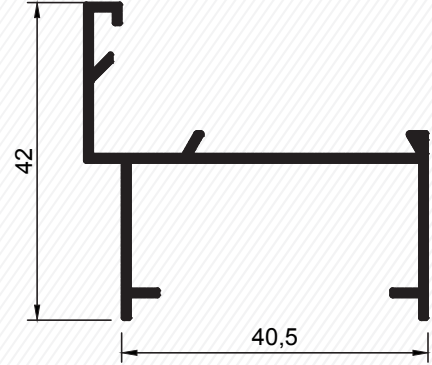

**1505**  
(0,432 kg/mt)

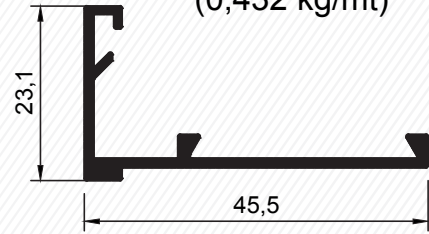

**1011**  
(0,318 kg/mt)

Kod	Et Kalın.	Ürün Adı	Ağırlığı
1130	1,5 mm	Adaptör Profili	0,378 kg/mt
1131	1,7 mm	Adaptör Profili	0,296 kg/mt

Cam Çıtası Profili - Glazing Bead Profile

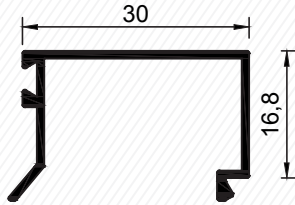

**1004**  
(0,215 kg/mt)

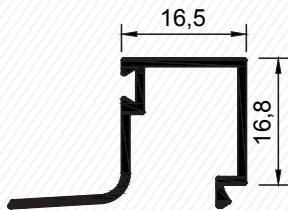

**1010**  
(0,224 kg/mt)

Cam Çıtası Profili - Glazing Bead Profile

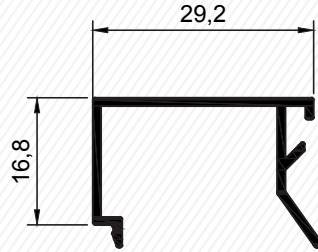

**6639**  
(0,230 kg/mt)

Tij Profili - Rod Profile

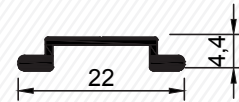

**1041**  
(0,095 kg/mt)

Tij Profili - Rod Profile

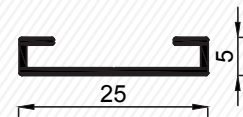

**1042**  
(0,109 kg/mt)